

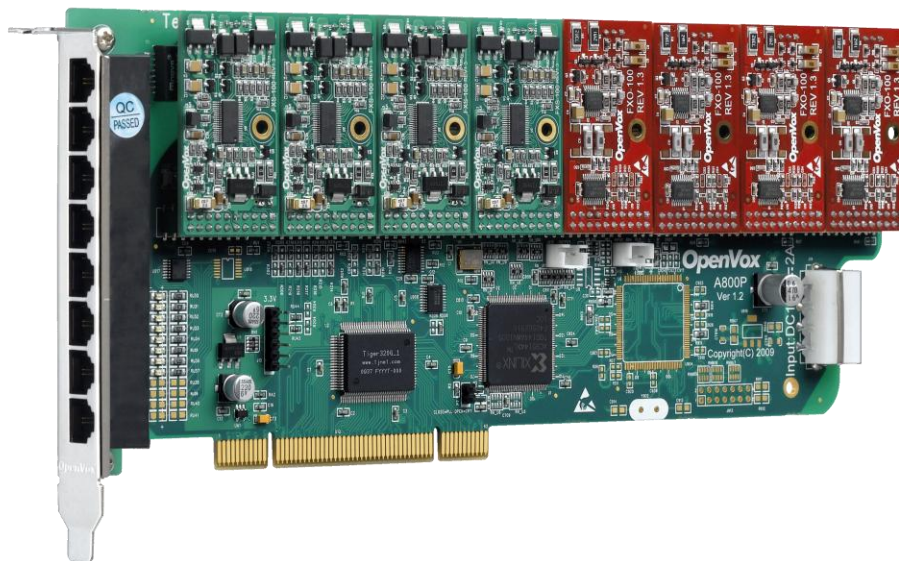

**OpenVox Communication Co.Ltd**



## **A800P on DAHDI User Manual**

Version: 2.2



## Copyright

Copyright© 2011 OpenVox Inc. All rights reserved. No part of this document may be reproduced without prior written permission.

## Confidentiality

Information contained herein is of a highly sensitive nature and is confidential and proprietary to OpenVox Inc. No part may be distributed, reproduced or disclosed orally or in written form to any party other than the direct recipients without the express written consent of OpenVox Inc.

## Disclaimer

OpenVox Inc. reserves the right to modify the design, characteristics, and products at any time without notification or obligation and shall not be held liable for any error or damage of any kind resulting from the use of this document.

OpenVox has made every effort to ensure that the information contained in this document is accurate and complete; however, the contents of this document are subject to revision without notice. Please contact OpenVox to ensure you have the latest version of this document.

## Trademarks

All other trademarks mentioned in this document are the property of their respective owners.

# Contents

<b>General Safety Instructions .....</b>	<b>4</b>
<b>Test Environments .....</b>	<b>5</b>
<b>Chapter 1 Overview.....</b>	<b>6</b>
1.1 What is Asterisk .....	6
1.2 What is A800P .....	7
<b>Chapter 2 Hardware Setup .....</b>	<b>10</b>
2.1 Power supply .....	10
2.2 Slot compatibility .....	10
2.3 Timing cable.....	11
2.4 FXO and FXS modules .....	11
2.5 Hardware setup procedure .....	12
<b>Chapter 3 Software Installation and Configuration.....</b>	<b>14</b>
3.1 Download .....	14
3.2 Installation.....	15
3.3 Configuration .....	19
<b>Chapter 4 Reference .....</b>	<b>26</b>
<b>Appendix A Specifications .....</b>	<b>27</b>
<b>Appendix B PIN Assignments .....</b>	<b>29</b>

## General Safety Instructions



### CAUTION

1. The computers that have A800P card installed must comply with the country's specific safety regulations.
2. Only service personnel should go to install A800P card.
3. Before installing A800P card, please unplug the power cord and remove the cover from your PC.
4. For avoiding personal injuries and damages to your machine and A800P card, make sure bracket of the card is secured to the PC's chassis ground by fastening the card with a screw.
5. Electrical Surges, ESD are very destructive to the equipment. To avoid it, make sure there is a low impedance discharge path from your computer to chassis ground.
6. To reduce the risk of damage or injury, please follow all steps or procedures as instructed.

## Test Environments

CentOS-5.6

Kernel version: 2.6.18-238.12.1.el5

DAHDI: dahdi-linux-complete-current

Asterisk: 1.8.0

Hardware: OpenVox A800P

## Chapter 1 Overview

### 1.1 What is Asterisk

The Definition of Asterisk is described as follows:

Asterisk is a complete PBX in software. It runs on Linux, BSD, Windows (emulated) and provides all of the features you would expect from a PBX and more. Asterisk does voice over IP in four protocols, and can interoperate with almost all standard-based telephony equipment using relatively cost-effective hardware. Asterisk provides Voicemail services with Directory, Call Conferencing, Interactive Voice Response, Call Queuing. It supports for three-way calling, caller ID services, ADSI, IAX, SIP, H323 (as both client and gateway), MGCP (call manager only) and SCCP/Skinny (voip-info.org).

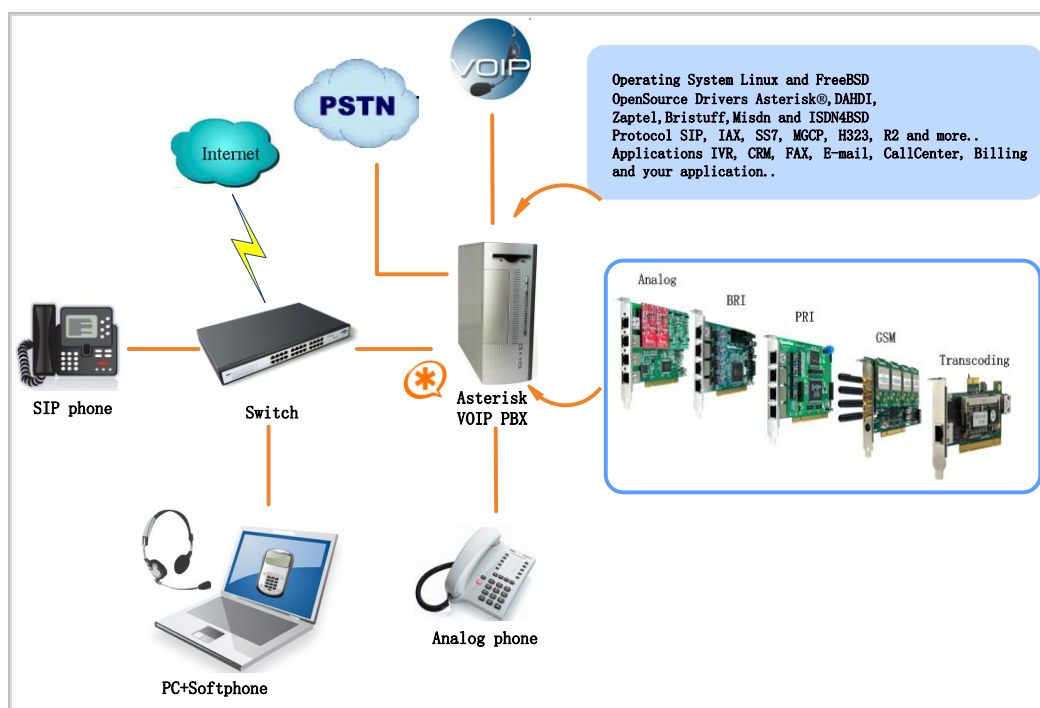

Figure 1 Topology

## 1.2 What is A800P

OpenVox A800P delivers great voice quality in the telephony systems.

With interchangeable FXS/FXO modules, it can eliminate the requirement for separate channel banks or access gateways.

The A800P contains 8 module banks. Each bank supports one analog interface. The module banks may be filled with up to 8 FXO or FXS modules enabling the creation of any combination of ports. Scaling of an analog card solution is accomplished by simply adding additional cards. A800P works with Asterisk<sup>®</sup>, Elastix<sup>®</sup>, FreeSWITCH<sup>™</sup>, PBX in a Flash, trixbox<sup>®</sup>, Yate<sup>™</sup> and IPPBX/IVR projects as well as other Open Source and proprietary PBX, Switch, IVR, and VoIP gateway applications.

### Sample application

When you need 4 PSTN lines and 4 extension sets, for example, 4 FXO-100 modules and 4 FXS-100 modules should be installed. PSTN lines correspond to FXO modules which are red while extension lines correspond to FXS modules which are green.

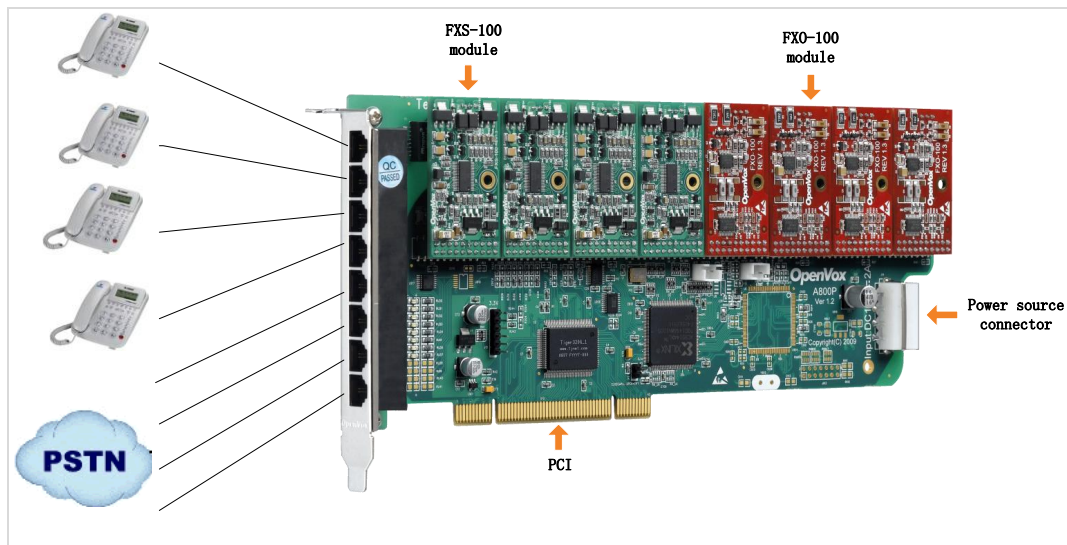

Figure 2 Sample application

### Key benefits

- High performance with low price
- Firmware accelerate I/O access achieve high stability and highly decreased CPU payload
- Modular Design: Up to 8 FXS, FXO or mixed FXS/FXO ports per card. Each port can be set as FXO or FXS via plugging different modules in it
- LEDs display the board's status
- Scalable: Just adding more cards to extend the system.
- Easy to use: the modules are Pin to Pin compatible with Digium's X100M and S100M.
- World Wide usable: Configurable line interface to meet global telephone line interface requirements



- RoHS compliant
- Certificates: CE, FCC, A-Tick
- trixbox™ Officially Certified
- Elastix® Officially Certified

**Features**

- Supports PCI 2.2 or above, 3.3 V and 5 V PCI slots
- Industry standard full size length PCI card
- Open source driver working with Zaptel, DADHI and so on.

## Chapter 2 Hardware Setup

There are some points that should be paid attention to when setting up A800P.

### 2.1 Power supply

The board should be powered when install any FXS module; please connect the power source with A800P board by a 4-pin power source connector.

### 2.2 Slot compatibility

A800P is compatible with 32-bit 5.0V PCI slot (slot 2), 64-bit 3.3V PCI slot (slot 3) or 64-bit 5.0V PCI slot (slot 4) while PCI-E slot is fit for A800E; you should confirm your slot type and insert A800P into any type of PCI slot as previously described.

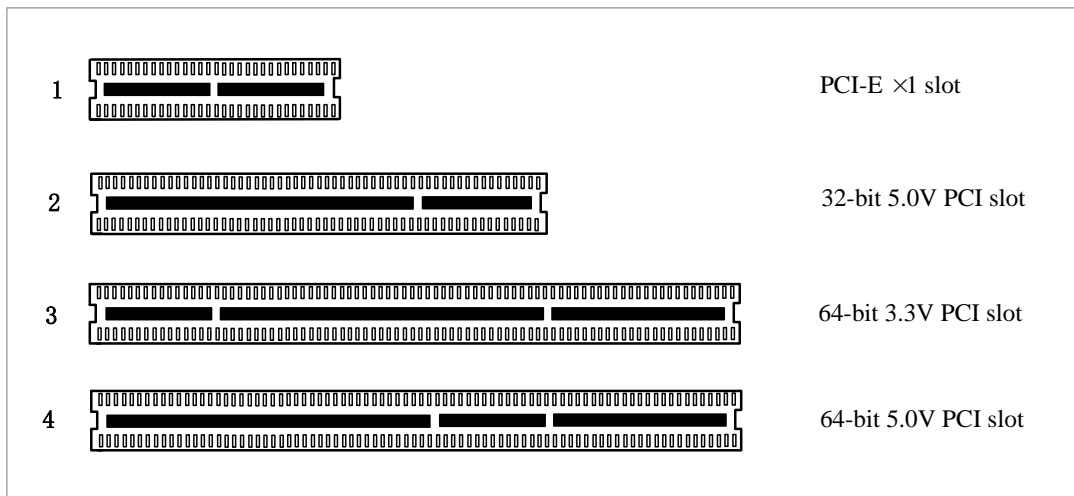

Figure 3 PCI-E and PCI slot

## 2.3 Timing cable

If you have just one card in the system, all channels on that card have already run under the same clock source, so timing cable is unnecessary. But if there are more than one card, using timing cable has some advantages. Before using the clock line, each card works on its own clock, therefore precision of the clock is limited; each card will send/receive voice data at different speeds. In voice usage, this small issue can be omitted, but in data communication such as Fax/Modem, it will cause big problem. Data loss will cause communication broken or fax broken. Timing cable will force all cards to work at the same clock source, send data at the same speed, as a result no data will lost.

If you found J914 (input) and J915 (output) interfaces on the card, it means the card supports clock line, for the details, please refer to [HERE](#).

## 2.4 FXO and FXS modules

There is so much difference between FXO modules and FXS modules, they can be identified by color, the former ones are red and the latter ones are green. FXO modules use FXS signaling while FXS modules use FXO signaling. FXO modules correspond to FXO port and the same with FXS modules and FXS ports. FXO ports allow A800P connect to PSTN lines and FXS ports connect to extension sets.

## 2.5 Hardware setup procedure

- Power off your PC, remember unplug the AC power cable
- Insert A800P into a 3.3V or 5.0V PCI slot
- Put timing cable correctly if necessary, for more details, please refer to [HERE](#)
- Please plug PSTN lines into FXO ports and extension telephone lines into FXS ports before you have detected your PSTN line works well.
- Fix the board by a screw
- Power on PC

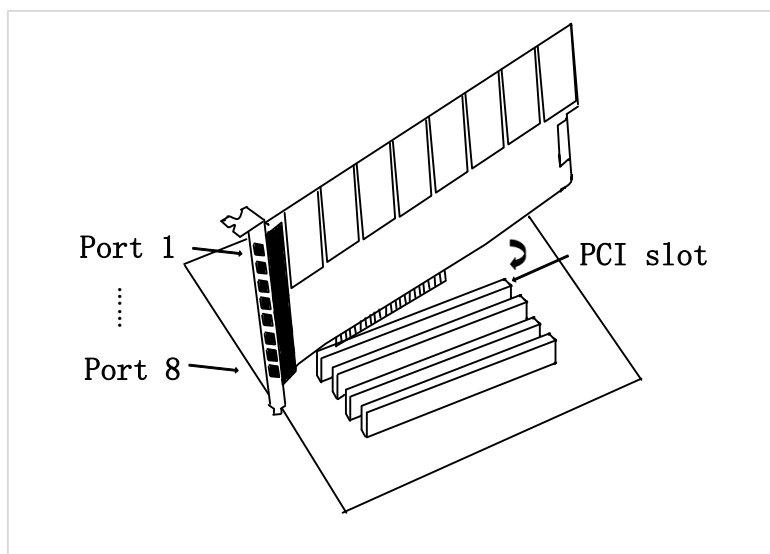

Figure 4 Hardware setup



**Caution:** If any FXS module is setup, you should make power on. During the above processes, an ESD wrist strap is needed. Once power is on, you must not attempt to

install or take down the board. Do not forget to connect PSTN lines into analog phones directly to make sure the lines are available before insert the PSTN lines into FXO ports. After hard ware setup, it is time to install software.



## Chapter 3 Software Installation and Configuration

A800P supports DAHDI software driver on Linux. To make full use of A800P, you should download, compile, install and configure DAHDI and Asterisk.

### 3.1 Download

DAHDI software packages are available on openvox official website or Digium. Some patches should be added while the driver source is from Digium, therefore, it is recommended that downloading the DAHDI driver package from openvox official website.

Gain DAHDI source package from OpenVox:

[http://downloads.openvox.cn/pub/drivers/dahdi-linux-complete/openvox\\_dahdi-linux-complete-current.tar.gz](http://downloads.openvox.cn/pub/drivers/dahdi-linux-complete/openvox_dahdi-linux-complete-current.tar.gz)

Get Asterisk software package from digium official website:

<http://downloads.asterisk.org/pub/telephony/asterisk/releases/asterisk-1.8.0.tar.gz>

Execute the following commands under the directory of /usr/src/ in general, the former two below are used for downloading these two packages and the later two are for unzipping them.

```
# wget http://downloads.openvox.cn/pub/drivers/dahdi-linux-complete/openvox_dahdi-linux-complete-current.tar.gz

# wget http://downloads.asterisk.org/pub/telephony/asterisk/releases/asterisk-1.8.0.tar.gz

# tar -xvzf openvox_dahdi-linux-complete-current.tar.gz

# tar -xvzf asterisk-1.8.0.tar.gz
```

## 3.2 Installation

### 1. Hardware detection

```
# lspci -vvvv
```

Check the outcome and confirm your system has recognized A800P. If it has been recognized, "communication controller" will be displayed in the output information like that:

```
01:02.0 Communication controller: Tiger Jet Network Inc. Tiger3XX
Modem/ISDN interface
    Subsystem: Device 9500:0003
    Control: I/O+ Mem+ BusMaster+ SpecCycle- MemWINV- VGASnoop-
ParErr- Stepping- SERR- FastB2B- DisINTx-
    Status: Cap+ 66MHz- UDF- FastB2B- ParErr- DEVSEL=medium
>TAbort- <TAbort- <MAbort- >SERR- <PERR- INTx-
    Latency: 64 (250ns min, 32000ns max)
    Interrupt: pin A routed to IRQ 5
    Region 0: I/O ports at c800 [size=256]
    Region 1: Memory at dedff000 (32-bit, non-prefetchable)
[size=4K]
    Capabilities: [40] Power Management version 2
    Flags: PMEClk- DSI+ D1- D2+ AuxCurrent=55mA PME(D0+,D1-
,D2+,D3hot+,D3cold+)
    Status: D0 NoSoftRst- PME-Enable- DSel=0 DScale=0 PME-
Kernel modules: opvxa1200, hisax
```

Figure 5 Hardware detection

If A800P is not recognized by the system, you have to power off and take out the card, then try to insert it into other PCI slot.

## 2. Software installation

Some dependencies are crucial. If any of them is absent, the software installation process would not go through successfully. Let's run "yum install XX" (XX stands for the dependency's name) to check the availability of dependencies.

```
# yum install bison
# yum install bison-devel
# yum install ncurses
# yum install ncurses-devel
```



```
# yum install zlib
# yum install zlib-devel
# yum install openssl
# yum install openssl-devel
# yum install gnutls-devel
# yum install gcc
# yum install gcc-c++
# yum install libxml2
# yum install libxml2-devel
```



If there is no kernel-devel source in the system, users should run the following command to install the kernel-devel to peer current kernel:

```
# yum install kernel-devel-`uname -r`
```

While if there is no matched kernel-devel found, you should download matched RPM package to install it, or execute the following command to update to the latest and stable kernel version:

```
# yum install kernel kernel-devel
```

After installed, please reboot your machine to apply the new kernel and install the dependencies. If the dependency has been installed, system indicates that nothing to do which means you could go to next one directly. Otherwise, the system will keep on installing it.

After install the dependencies, please change to the directory dahdi-linux-complete-XX (XX represents DAHDI version), then perform the following commands one by one to install DAHDI.

```
# cd /usr/src/dahdi-linux-complete-XX
# make
# make install
# make config
```



**Caution:** If there is something wrong after "make", please refer to [HERE](#). In the url link, the moderator introduces you a method how to patch. After patching, save your changes and exit. Then run "make" again, if successfully, you are going to install Asterisk.

Please operate those commands to install Asterisk.

```
# cd asterisk-1.8.0
# ./configure
# make
# make install
# make samples
```



"make samples" will install the standard sample configuration file in the directory /etc/asterisk. As a freshman, you should perform make samples, that is to say, it is unnecessary to perform make samples every time. Because once performed, it will cover the old sample configuration files you have installed.

### 3.3 Configuration

#### 1. Driver loading

After compiling and installing DAHDI and Asterisk, please load the driver by running:

```
# modprobe dahdi
# modprobe opvxa1200 opermode=CHINA
# dahdi_genconf
```



After running "modprobe dahdi" or "modprobe wctdm opermode=CHINA", there is not any indication information displayed if loaded normally and successfully. opvxa1200 is the driver module name of A800P.

"opermode" applies to FXO port and is invalid for FXS port, and you are allowed to take place of "CHINA" to other mode name which is

available in the file:

```
../dahdi-linux-XX/linux/drivers/dahdi/fxo_modules.h
```

If there is any error, please trace the cause. Until all errors are clear up, you could execute "dahdi\_genconf" again, and then go to the next step. By running "dahdi\_genconf", it will generate /etc/dahdi/system.conf and etc/asterisk/dahdi-channels.conf automatically. Checking whether the generated files information agrees with your hardware setup, if not, you should modify to your specific requirements. Do not forget to confirm dahdi-channels.conf is included in chan\_dahdi.conf, if not, run command:

```
# echo "#include dahdi-channels.conf" >>  
/etc/asterisk/chan_dahdi.conf
```

FXO ports use FXS signaling, while FXS ports adopt FXO signaling. A part of system.conf which is one of the basic channel configuration files is displayed.

```
# Span 1: OPVXA1200/12 "OpenVox A1200P/A800P Board 13"
fxoks=1
fxoks=2
fxoks=3
fxoks=4
fxsks=5
fxsks=6
fxsks=7
fxsks=8

# Global data

loadzone      = us
defaultzone   = us
```

Figure 6 A part of system.conf

## 2. Country mode modification

In order to match your country pattern, you need to change parameters loadzone and defaultzone to your country. For example, your system is in CHINA, you would like them change to:

```
loadzone = cn
```

```
defaultzone = cn
```



Some zonedata is available in the file

../dahdi-XX/tools/zonedata.c, you can refer to it to match your country mode. Meanwhile, you also need to modify another parameter which is in file

/etc/asterisk/indications.conf.

```
country=cn
```

A part of file `/etc/asterisk/dahdi-channels.conf` is showed as below.

(Modification, if it is not agree with the hardware setup)

```
; Span 1: OPVXA1200/12 "OpenVox A1200P/A800P Board 13"
;;; line="1 OPVXA1200/12/1 FXOKS"
signalling=fxo_ks
callerid="Channel 1" <4001>
mailbox=4001
group=5
context=from-internal
channel => 1
callerid=
mailbox=
group=
context=default

;;; line="2 OPVXA1200/12/2 FXOKS"
signalling=fxo_ks
callerid="Channel 2" <4002>
mailbox=4002
group=5
context=from-internal
channel => 2
callerid=
mailbox=
group=
context=default
.....
.....

;;; line="5 OPVXA1200/12/5 FXSKS"
signalling=fxs_ks
callerid=asreceived
group=0
context=from-pstn
channel => 5
callerid=
group=
context=default

;;; line="6 OPVXA1200/12/6 FXSKS"
signalling=fxs_ks
callerid=asreceived
group=0
context=from-pstn
channel => 6
callerid=
group=
context=default
.....
.....
```

Figure 7 A part of `dahdi-channels.conf`

After modifying the country mode, please execute the following command:

```
# dahdi_cfg -vvvvvv
```

The command is used for reading and loading parameters in the configuration file `system.conf` and writing to the hardware. A part of outputs are showed in the following figure.

```
Channel map:

Channel 01: FXO Kewlstart (Default) (Echo Canceler: none) (Slaves: 01)
Channel 02: FXO Kewlstart (Default) (Echo Canceler: none) (Slaves: 02)
Channel 03: FXO Kewlstart (Default) (Echo Canceler: none) (Slaves: 03)
Channel 04: FXO Kewlstart (Default) (Echo Canceler: none) (Slaves: 04)
Channel 05: FXS Kewlstart (Default) (Echo Canceler: none) (Slaves: 05)
Channel 06: FXS Kewlstart (Default) (Echo Canceler: none) (Slaves: 06)
Channel 07: FXS Kewlstart (Default) (Echo Canceler: none) (Slaves: 07)
Channel 08: FXS Kewlstart (Default) (Echo Canceler: none) (Slaves: 08)

8 channels to configure.

Setting echocan for channel 1 to none
Setting echocan for channel 2 to none
Setting echocan for channel 3 to none
Setting echocan for channel 4 to none
Setting echocan for channel 5 to none
Setting echocan for channel 6 to none
Setting echocan for channel 7 to none
Setting echocan for channel 8 to none
```

Figure 8 Channel map

### 3. Asterisk initiation

```
# asterisk -vvvvvvvgc
```

If Asterisk is already activate, run "asterisk -r" instead. In the CLI, please run the following command:

```
localhost*CLI> dahdi show channels
```

Chan Pseudo	Extension	Context	Language	MOH Interpret
		default		default
	1	from-internal		default
	2	from-internal		default
	3	from-internal		default
	4	from-internal		default
	5	from-pstn		default
	6	from-pstn		default
	7	from-pstn		default
	8	from-pstn		default

Figure 9 channels show

If dahdi channels are found, it means they have been loaded into Asterisk.

You are going to edit dialplan by your requirements.

#### 4. Dialplan edit

Users must make sure that the context "from-pstn" and "from-internal" are in extensions.conf, here a simple example is given:

```
# vim /etc/asterisk/extensions.conf
```

```
[from-pstn]
exten => s,1,Answer()
exten => s,n,Dial(dahdi/1,,r)
exten => s,n,Hangup()

[from-internal]
exten => 200,1,Dial(dahdi/7/outgoing_number)
exten => 200,2,Hangup()
```

Figure 10 dialplan show





You should write the destination number instead of the `outgoing_number` in the above dial plan. The above dial plan achieves that when an extension telephone dials 200, Asterisk will transfer through channel 7 to the destination.

While a call comes from PSTN line, Asterisk answers firstly, and then gets through to the extension set which connects to channel 1.

After saving your dialplan, please run "`asterisk -r`", then execute "`reload`" in the CLI. Next you are able to make calls.

## Chapter 4 Reference

[www.openvox.cn](http://www.openvox.cn)

[www.digium.com](http://www.digium.com)

[www.asterisk.org](http://www.asterisk.org)

[www.voip-info.org](http://www.voip-info.org)

[www.asteriskguru.com](http://www.asteriskguru.com)

### Tips

Any questions during installation please consult in our forum or look up for answers from the following websites:

[Forum](#)

[wiki](#)

## Appendix A Specifications

### • Weight and size

Weight: 133g (4.69oz)

Size: 24.8×10.7×1.8cm (9.76×4.21×0.71 inch)

### • Interfaces

PCI Bus: 3.3V or 5V bus slot, PCI 2.2 or above

Power Supply Connect: 12V 4-pin connector (When any FXS modules are installed)

Local Loop Access: Four industry standard RJ-11 ports

### • Environment

Temperature: 0 ~ 50 °C (Operation)

- 40 ~ 125 °C (Storage)

Humidity: 10 ~ 90% NON-CONDENSING

### • Power consumption

Voltage: 3.3V/5V/12V,3REN

Power consuming: less than 37W (with full eight FXS modules); less than 7W (with full eight FXO modules).

### • Hardware and software requirements

RAM 128 + MB

Linux kernel 2.4.X or 2.6.X

CPU 800+ MHZ



## Appendix B PIN Assignments

Either 4-pin or 6-pin RJ11 port is compatible with A800P, let's illustrate pin assignments of RJ11 port by the following tables.

### 4-pin RJ11 port

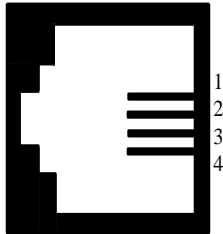
4-pin RJ11 port	PIN	Description
	1	Not used
	2	Tip
	3	Ring
	4	Not used

### 6-pin RJ11 port

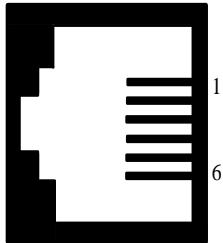
6-pin RJ11 port	PIN	Description
	1	Not used
	2	Not used
	3	Tip
	4	Ring
	5	Not used
	6	Not used