

# QuMax for Teltonika

## RUT951/RUT950/RUT901

Integrated outdoor multi band high power LTE directional antenna + outdoor Wi-Fi omni antenna + place to install Teltonika RUT951, RUT950 or 900 (All-in-one)

QuMAX offers the most powerful directional LTE antenna of all QuWireless antennas. It is dedicated to connections with long distance to base station. It is designed to have Teltonika **RUT951, RUT950** or **RUT901** router installed inside IP67 enclosure. It is the first choice for fixed installations in industrial environment. **It has embedded also outdoor Wi-Fi omni antennas.**

**4G**  
LTE**Wi Fi** 2.4GHz  
6 dBi  
DIRECTIONAL  
IP 67  
-40° TO +80°

OUTDOOR ANTENNA WORKS **IN ANY**  
WEATHER CONDITIONS, IP67



ANTENNA **PERFECTLY MATCHED** WITH  
THE ROUTER



PASSIVE **POE** SUPPORT



MADE IN **EUROPE**

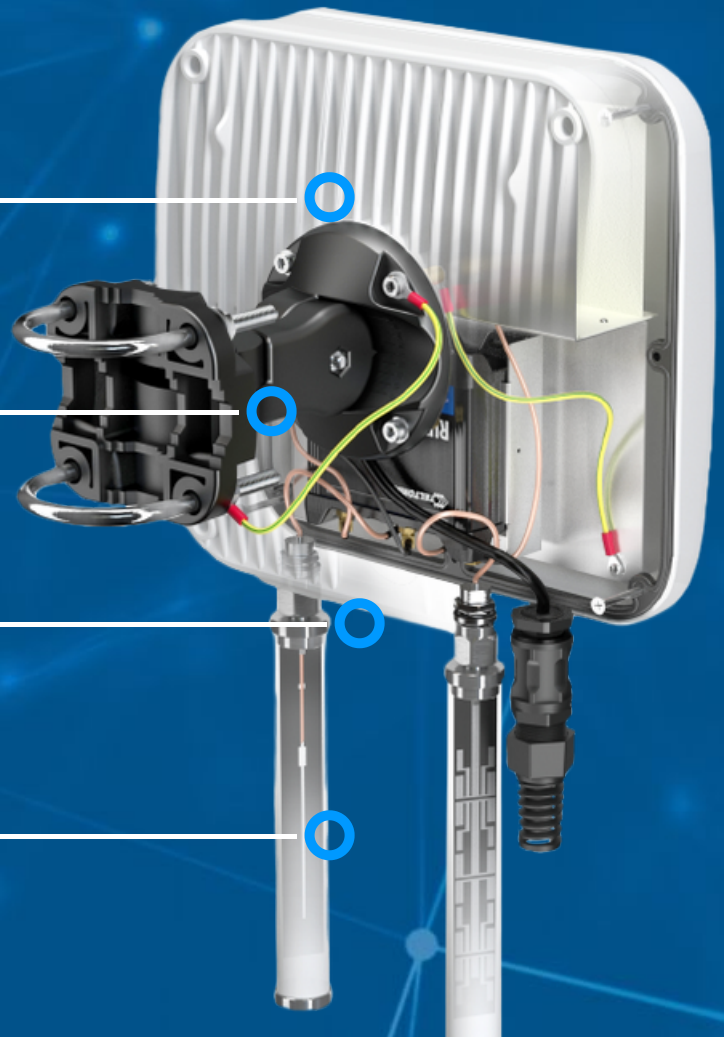

## LTE ANTENNA SPECIFICATION

<b>FREQUENCY</b>	694 - 960 MHz 1.7 - 2.2 GHz 2.2 - 2.7 GHz
<b>SUPPORTED LTE/5G BANDS</b>	1, 2, 3, 4, 5, 7, 8, 9, 10, 12, 13, 14, 17, 18, 19, 20, 25, 26, 27, 28, 29, 30, 33, 34, 35, 36, 37, 38, 39, 40, 41, 44, 53, 65, 66, 67, 68, 69, 85, 103, n80, n81, n82, n83, n84, n86, n89, n90, n95, n97, n98, n100, n101, n256
<b>GAIN</b>	694 - 960 MHz : 4 dBi 1.7 - 2.2 GHz : 5 dBi 2.2 - 2.7 GHz : 6 dBi
<b>FRONT-TOBACK</b>	>8 dB
<b>VSWR</b>	<1.30, max <1.80
<b>BEAMWIDTH</b>	90°/90° ±30°
<b>POLARIZATION</b>	Vertical
<b>IMPEDANCE</b>	50 Ω

## WI-FI ANTENNA SPECIFICATION

<b>FREQUENCY</b>	2.4 - 2.5 GHz
<b>GAIN</b>	6 dBi
<b>VSWR</b>	<1.70, max <2.00
<b>BEAMWIDTH</b>	360°/25° ±5°
<b>POLARIZATION</b>	Vertical
<b>IMPEDANCE</b>	50 Ω

## MECHANICAL SPECIFICATION

<b>MATERIALS</b>	ABS, aluminum, PTFE, Fiberglass
<b>CONNECTOR TYPE</b>	RJ45 + 2xNf + 2xNm in external omni wi-fi antenna
<b>INGRESS PROTECTION</b>	IP67
<b>DIMENSIONS</b>	272 x 276 x 96 mm 10.71 x 10.87 x 3.78 inch
<b>WEIGHT</b>	1.8 kg 3.97 lbs
<b>OPERATING TEMPERATURE</b>	From -40°C to 80°C From -40°F to 176°F
<b>MAST DIAMETER</b>	25-60mm 0.98-2.36 inch

## FREQUENCY BANDS

<b>LTE / 4G GSM</b>	5	6	8	12	13	14	17	694 MHz	960 MHz
	18	19	20	25	27	28	29		
	44	67	68	85	n81	n82	n83		
	n89								
<b>LTE / 4G UMTS</b>	1	2	3	4	9	10	25	1710 MHz	2170 MHz
	33	34	35	36	37	39	59		
	62	n80	n84	n86	n95				

LTE / 4G WCS DARS

2300  
MHz

30

40

2400  
MHz

LTE / 4G

2400  
MHz

7

38

41

53

69

n90

2700  
MHz

## PLOTS

VSWR for LTE antenna

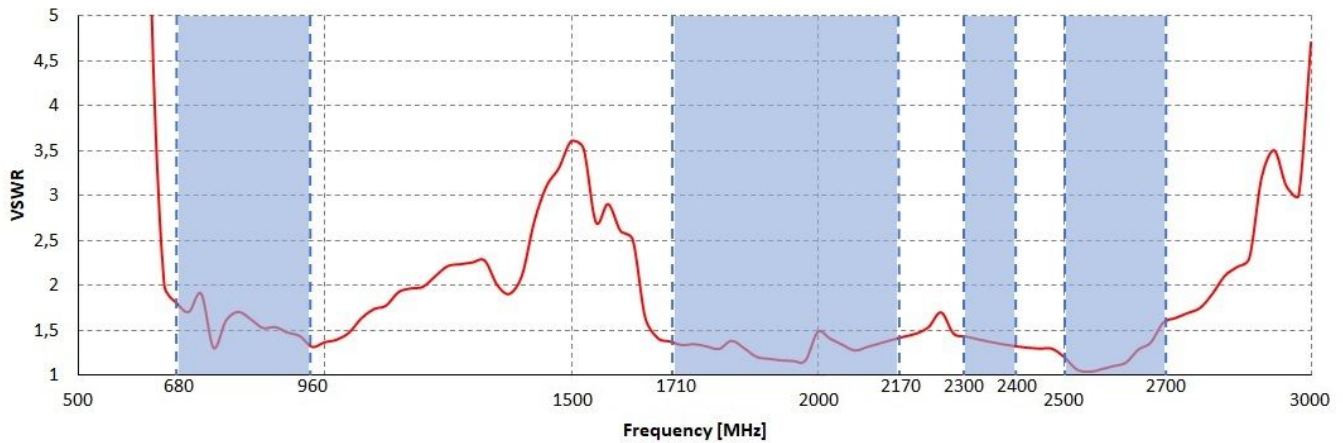

VSWR for Wi-Fi antenna

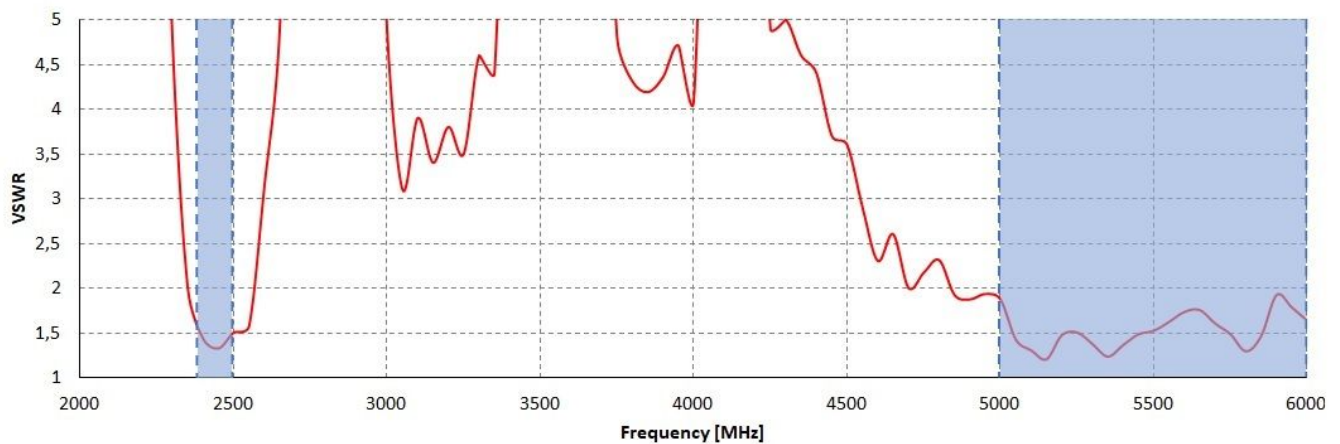

Gain for LTE antenna

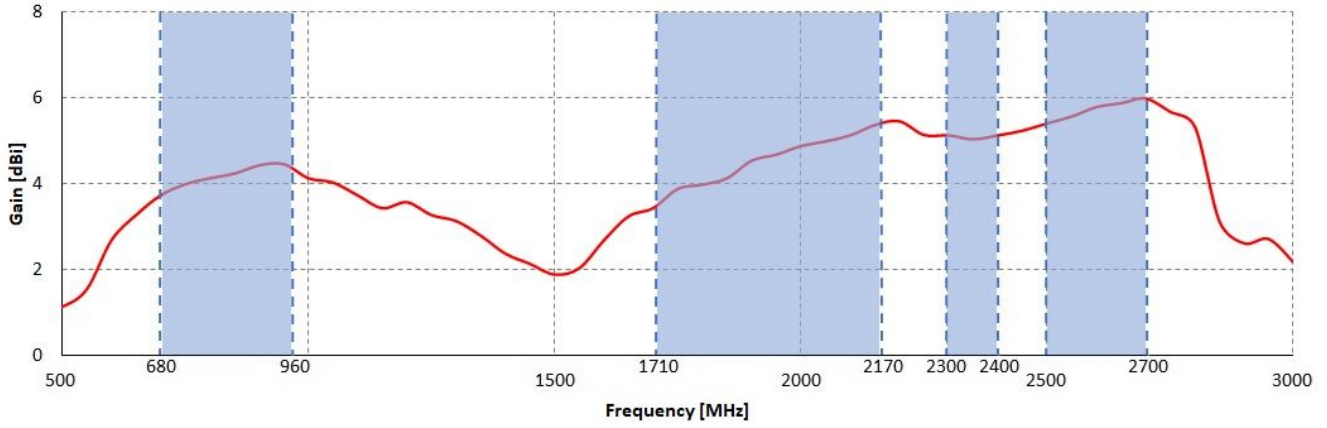

Gain for Wi-Fi antenna

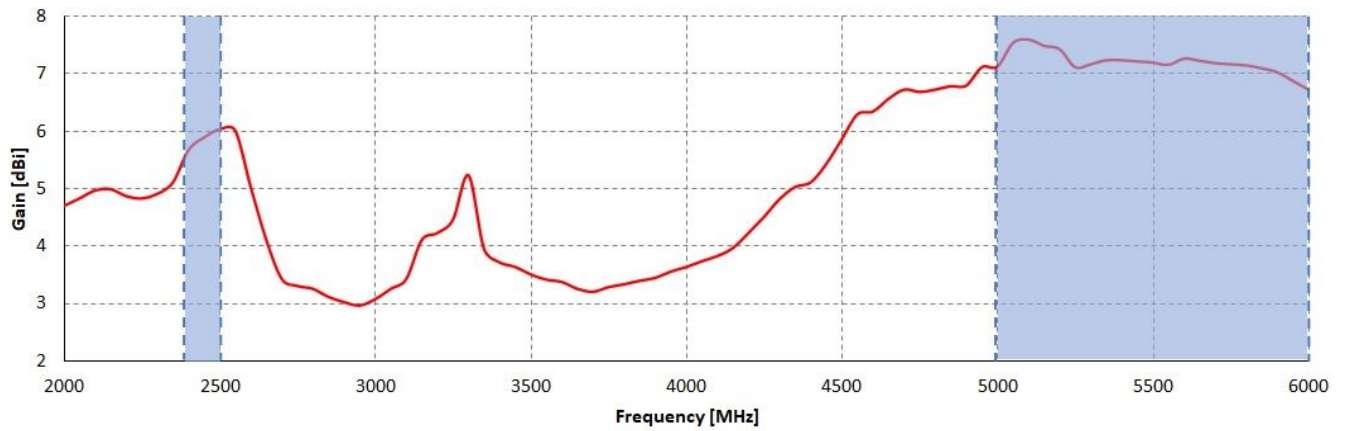

LTE from 700MHz to 900MHz

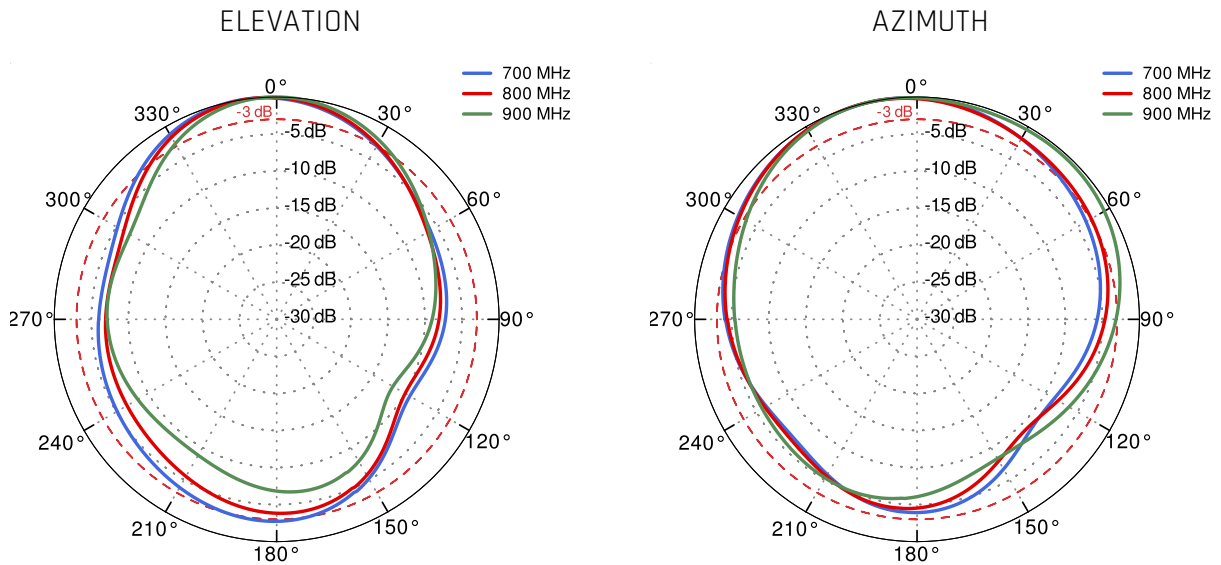

LTE from 1.71GHz to 2.17GHz

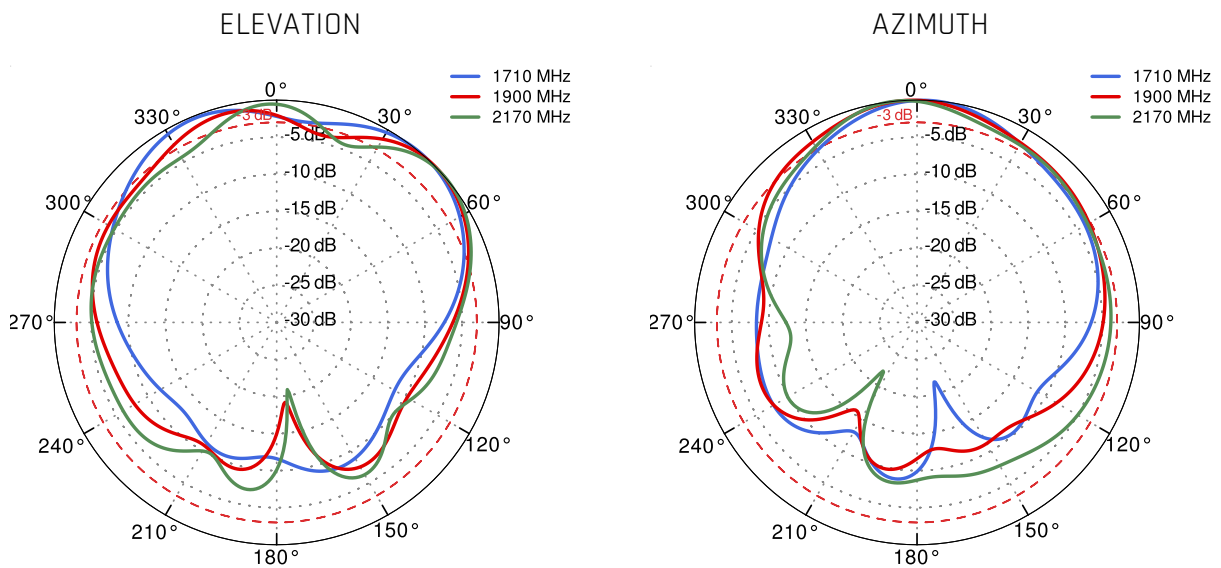

LTE from 2.3GHz to 2.7MHz

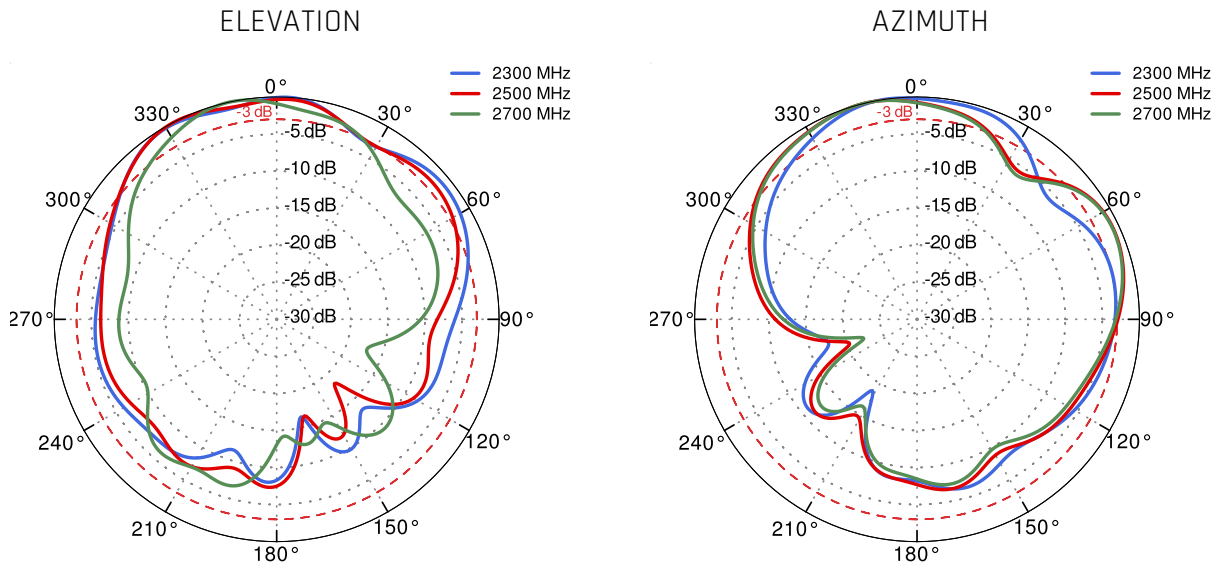

Wi-Fi 2.4GHz and 5GHz

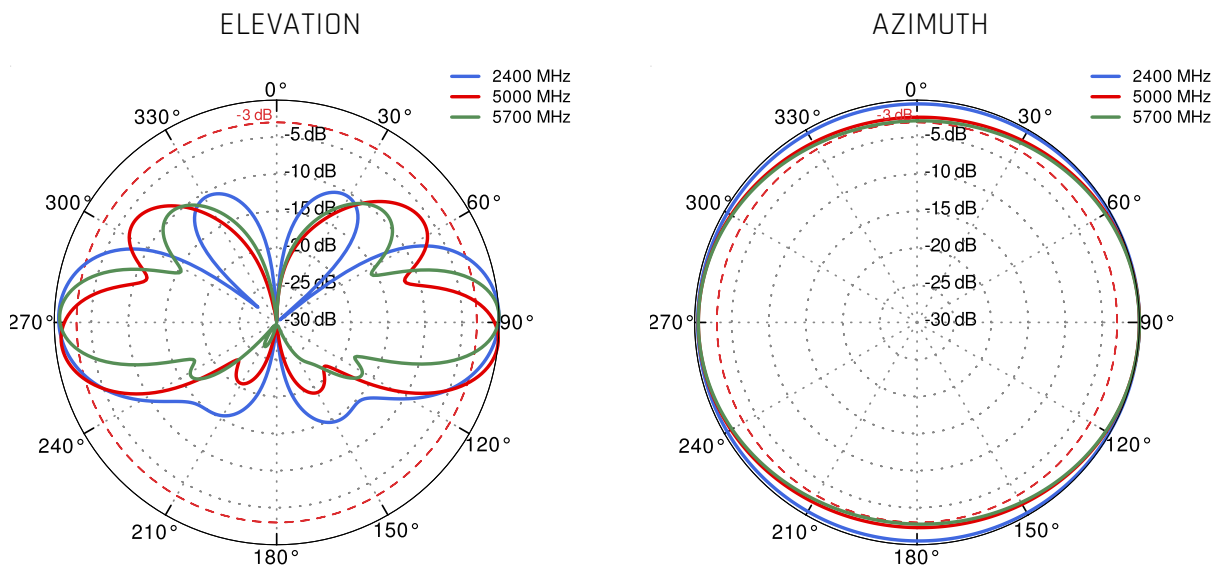

## DIMENSIONS

