

StarterDish™ 24 UM

DIRECTIONAL PARABOLIC DISH ANTENNA

StarterDish™ antennas are designed for CPE applications. Antenna is light weight with their reflector made of aluminium. StarterDish™ antennas provide excellent beam performance in cost effective package. Antennas are easy to assemble and come in highly economical 5 packs.



Gain H

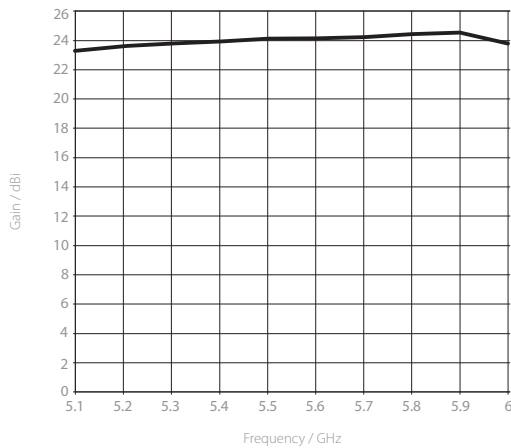

Azimuth Pattern H

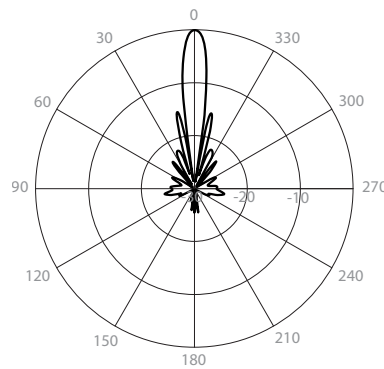

H - Port Pattern Azimuth 5.6 GHz

Elevation Pattern H

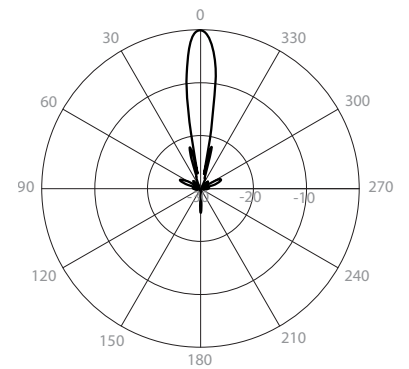

H - Port Pattern Elevation 5.6 GHz

Gain V

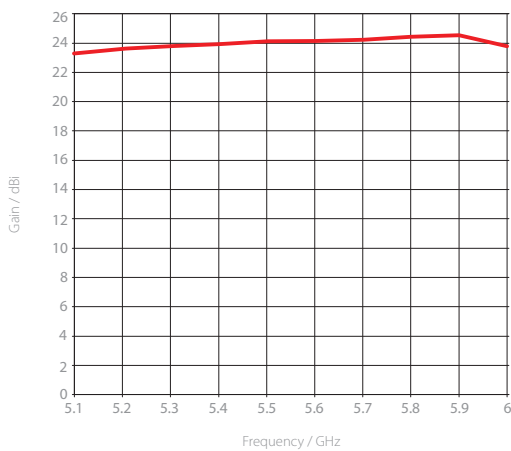

Azimuth Pattern V

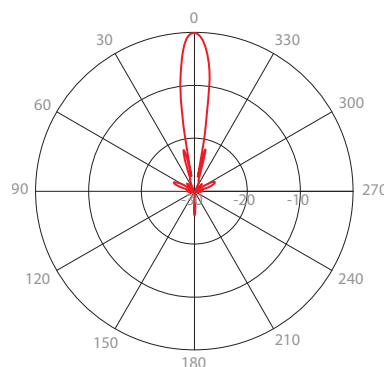

V - Port Pattern Azimuth 5.6 GHz

Elevation Pattern V

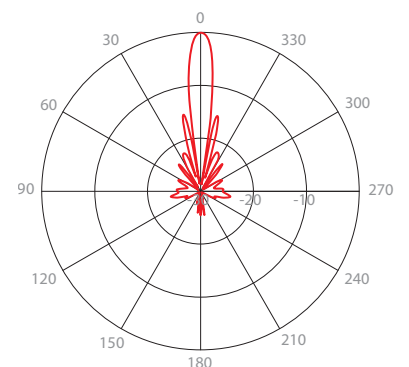

V - Port Pattern Elevation 5.6 GHz

PHYSICAL

Antenna Connection	Waveguide Port
Antenna Type	Parabolic Dish
Environmental	IP65
Pole Mounting Diameter	20-55 mm (recommend as close to 55 mm as possible)
Temperature	-35 °C to + 55 °C (-31 °F to + 131 °F)
Wind Survival	160 km/hour
Wind Loading	92 N at 160 km/hour
Mechanical Adjustment	± 15° Elevation
Weight	1.5 kg / 3.3 lbs – single unit (one antenna) 10.5 kg / 23.1 lbs – 5PACK (5 units) incl. package
Dimensions	Retail Box 5PACK: 695 x 447 x 110 mm / 27.3 x 17.5 x 4.3 inch

PERFORMANCE

Gain	24 dBi
Frequency Range	5150 - 5950 MHz
Azimuth Beam Width -6 dB	H 12° / V 12°
Elevation Beam Width -6 dB	H 12° / V 12°
Azimuth Beam Width -3 dB	H 8° / V 8°
Elevation Beam Width -3 dB	H 8° / V 8°
Beam Efficiency*	34%
Front-to-Back Ratio (Min)	27 dB

COMPATIBLE WIRELESS PLATFORMS

RF elements®	StarterAdapter™ SMA
Mimosa® by Airspan	C5x
Ubiquiti Networks®	PrismStation™ 5AC, IsoStation™ 5AC, IsoStation™ M5

PRODUCT DIMENSIONS

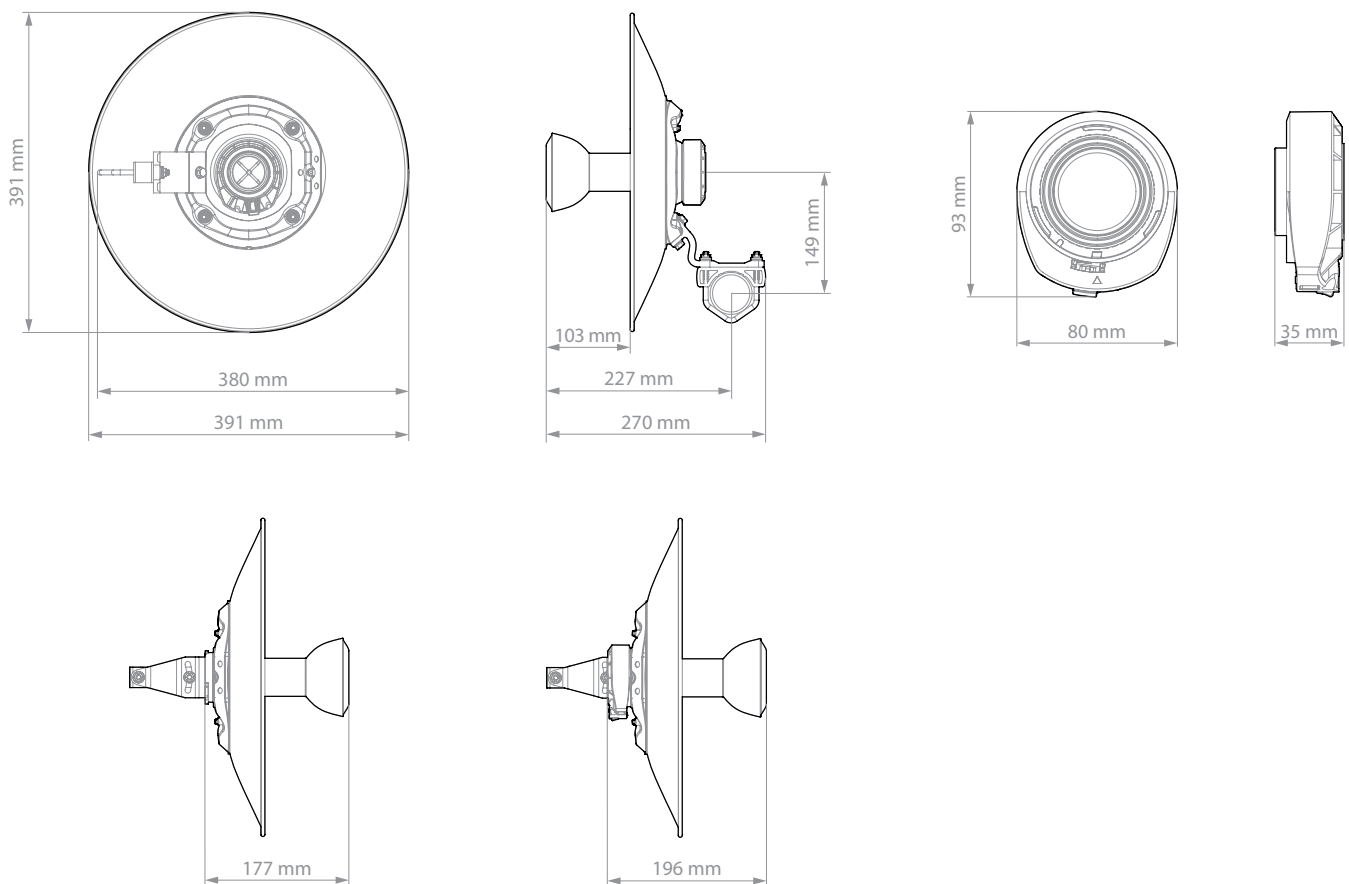

*Main beam defined up to first null