

accessories



accessories



FIXED SHELVES



Fixed Shelf
D 600 mm

- 19" Rack mountable
- 4 fixing point
- No barrier for airflow inside of rack with slotted structure
- 50 kg static load carrying capacity



Fixed Shelf
D 800 mm

Color Options

- RAL 9005 - Siyah (Standart)
- RAL 7035 - Açık Gri (Opsiyonel)



Fixed Shelf
D 1000 mm

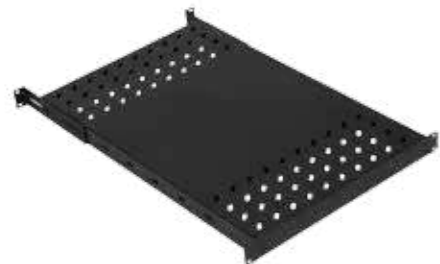

Fixed Shelf
D 1000 mm
(Heavy duty type)

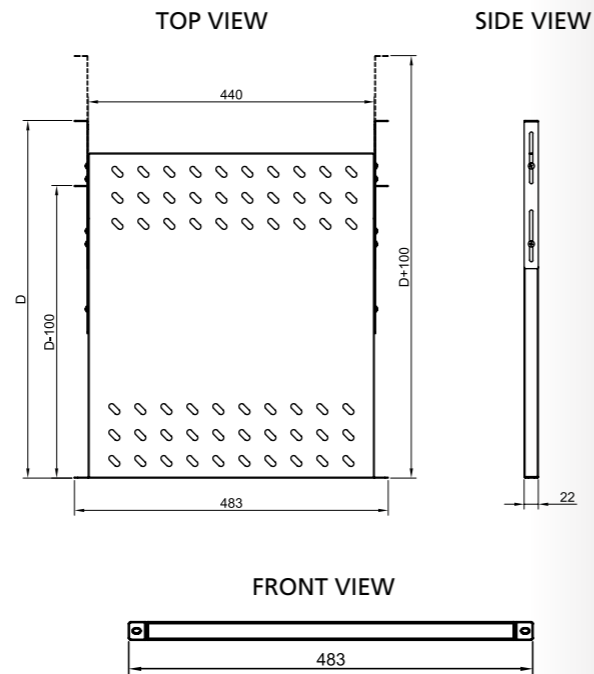

FIXED SHELVES

Product Code	Product Description	Width (W) (mm)	Depth (D) (mm)	Height (H) (mm)	Weight (Kg)
PA CC RK SR 60	1/2U Fixed Shelf - 600 mm Depth Cabinets	483	360	22	1,80
PA CC RK SR 80	1/2U Fixed Shelf - 800 mm Depth Cabinets	483	560	22	2,80
PA CC RK SR 10	1/2U Fixed Shelf - 1000 mm Depth Cabinets	483	760	22	3,40
PA CC RK SR 10 HD	1U Fixed Shelf- 1000 mm Depth Cabinets (Heavy Duty Type)	483	760	44	5,40

**CC Means=Color Code, BL=Rall 9005 Black, LG=Rall 7035 Light Gray

SLIDING SHELVES

- 19" Rack mountable
- 4 fixing point
- No barrier for airflow inside of rack with slotted structure
- 35 kg static load carrying capacity
- Shelves could be moved along the depth of cabinet
- Adjustable depth by 100mm with rear moveable L bracket throughout front and rear 19" rails.
- The side latch

Color Options

- RAL 9005 - Siyah (Standart)
- RAL 7035 - Açık Gri (Opsiyonel)

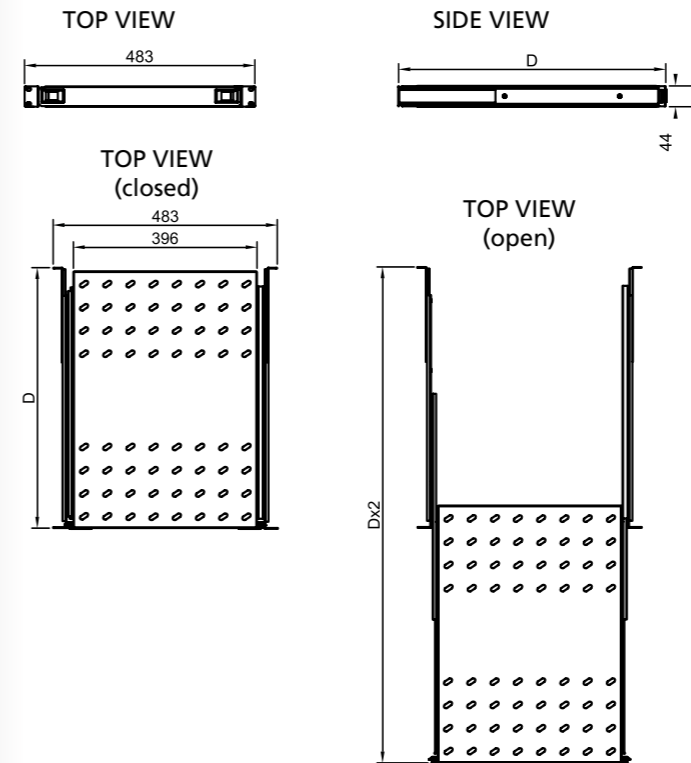

Sliding Shelf
D 600 mm

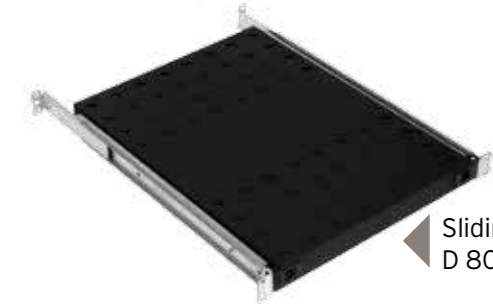

Sliding Shelf
D 800 mm

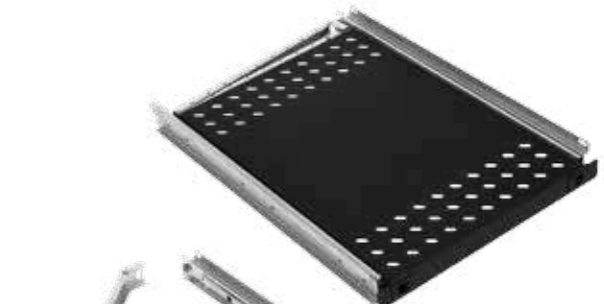

Sliding Shelf
D 1000 mm

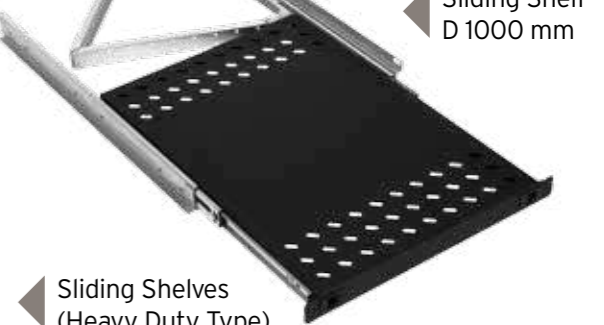

Sliding Shelves
(Heavy Duty Type)
D 1000 mm

SLIDING SHELVES

Product Code	Product Description	Width (W) (mm)	Depth (D) (mm)	Height (H) (mm)	Weight (Kg)
PA CC RK HR 60	Sliding Shelves 600 mm Depth Cabinets	483	360	44	2,80
PA CC RK HR 80	Sliding Shelves 800 mm Depth Cabinets	483	560	44	4,00
PA CC RK HR 10	Sliding Shelves 1000 mm Depth Cabinets	483	760	44	5,00
PA CC RK HR 10 HD	Sliding Shelves 1000 mm Depth Cabinets (Heavy Duty Type)	483	760	44	6,30

**CC Means=Color Code, BL=Rall 9005 Black, LG=Rall 7035 Light Gray

CANTILEVER SHELVES

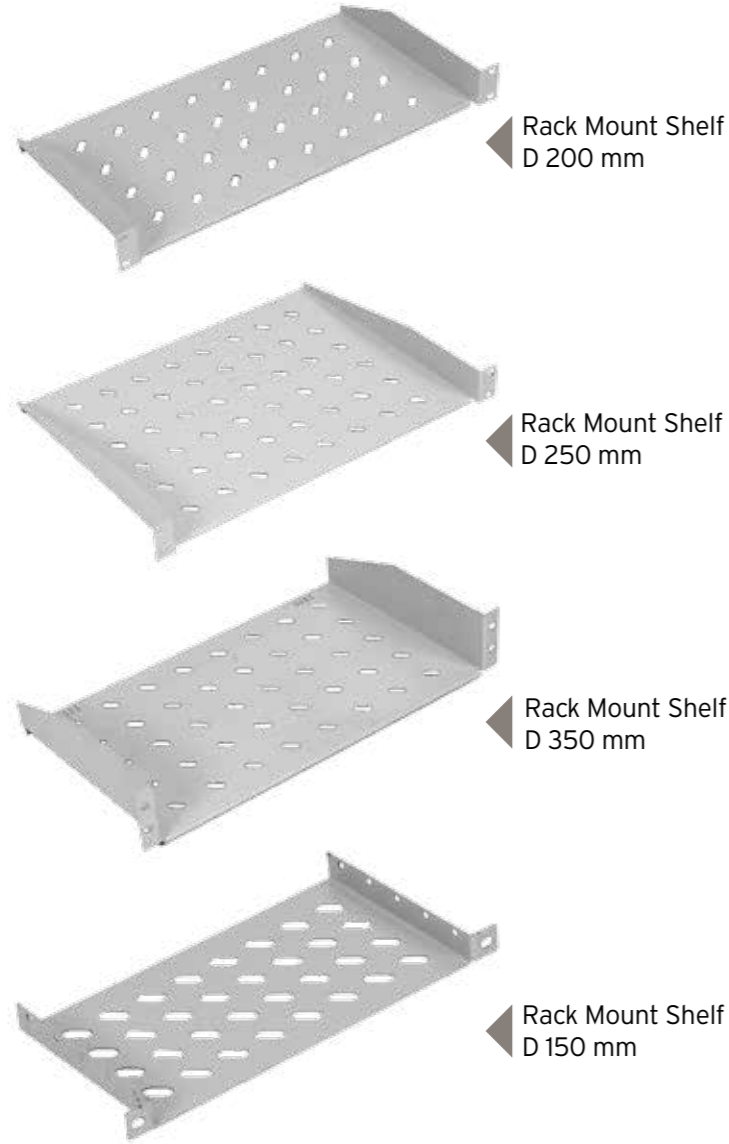

- 19" Rack mountable
- No barrier for airflow inside of rack with slotted structure
- 50kg static load carrying capacity

Color Options

- RAL 7035 - Light Gray (Standard)
- RAL 9005 - Signal Black (Optional)

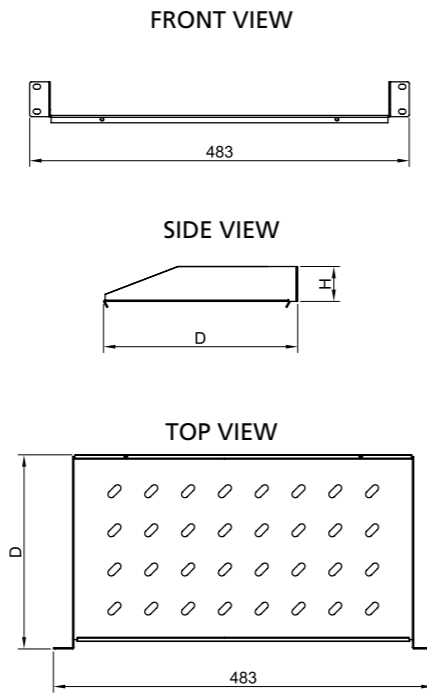

CANTILEVER SHELVES

Product Code	Product Description	Width (W) (mm)	Depth (D) (mm)	Height (H) (mm)	Weight (Kg)
PA CC RK MR 1U 20	1U 19" D=200 mm Cantilever Shelves	483	200	44	1,25
PA CC RK MR 1U 25	1U 19" D=250 mm Cantilever Shelves	483	250	44	1,50
PA CC RK MR 1U 35	1U 19" D=350 mm Cantilever Shelves	483	350	44	2,10
PA CC RK MR 2U 30	2U 19" D=300 mm Cantilever Shelves	483	300	88	2,00
PA CC RK MR 2U 35	2U 19" D=350 mm Cantilever Shelves	483	350	88	2,30
PA CC RK MR 2U 40	2U 19" D=400 mm Cantilever Shelves	483	400	88	2,50
PA CC RK MR 3U 40	3U 19" D=400 mm Cantilever Shelves	483	400	132	3,00
PA CC RK MR YU 1015	1/2U 10" D=150 mm Cantilever Shelves	483	150	22	0,40

**CC Means=Color Code, BL=Rail 9005 Black, LG=Rail 7035 Light Gray

DRAWERS

- 19" SRack mountable
- 3U Height (177mm)
- 4 fixing point
- Lockable with single point lock
- 50 kg static load carrying capacity
- Adjustable depth by 60mm with rear moveable L bracket throughout front and rear 19" rails.

Color Options

- RAL 7035 - Light Gray (Standard)
- RAL 9005 - Signal Black (Optional)

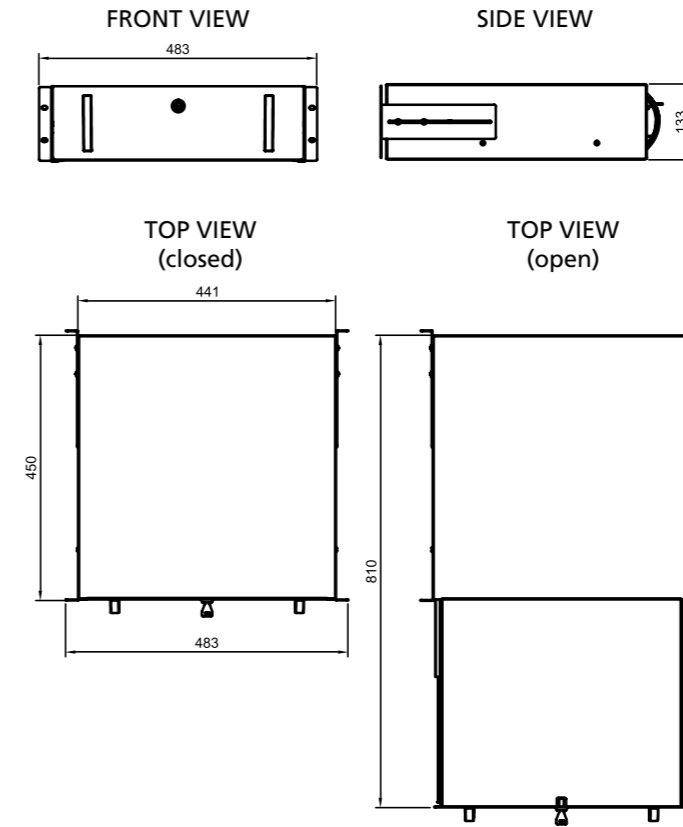

DRAWERS

Product Code	Product Description	Width (W) (mm)	Depth (D) (mm)	Height (H) (mm)	Weight (Kg)
PA CC RK CM 2U 45	2U 19" Drawers D=450 mm	483	450	88	8,00
PA CC RK CM 3U 45	3U 19" Drawers D=450 mm	483	450	133	10,50

**CC Means=Color Code, BL=Rail 9005 Black, LG=Rail 7035 Light Gray

1U KEYBOARD DRAWER

- 19" Rack mountable
- 1U Height (44mm)
- 4 fixing point
- Lockable with single point lock
- 25kg static load carrying capacity
- Adjustable depth by 60mm with rear moveable L bracket throughout front and rear 19" rails.

Color Options

- RAL 9005 - Black (Standard)
- RAL 7035 - White (Optional)

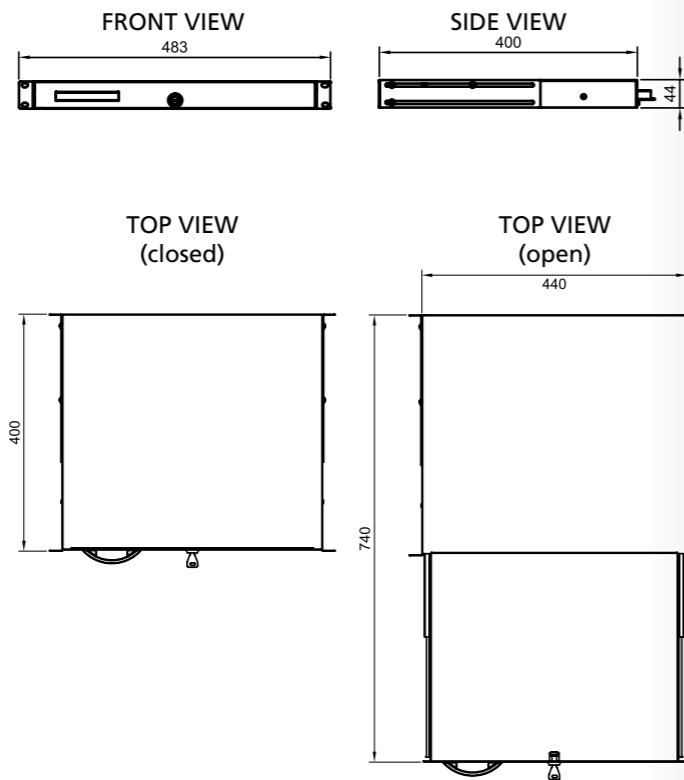

1U KEYBOARD DRAWER

Product Code	Product Description	Width (W) (mm)	Depth (D) (mm)	Height (H) (mm)	Weight (Kg)
PA CC RK CM 1U 45	1U 19" Keyboard Drawers	483	400	44	5.70

**CC Means=Color Code, BL=Rail 9005 Black, LG=Rail 7035 Light Gray

HORIZONTAL CABLE ORGANIZERS

- 19" Rack mountable
- Metal or plastic hooks
- User friendly design



▶ 1U 19" Horizontal organizer with 5 metal hooks



▶ 2U 19" Horizontal organizer with 5 metal hooks



▶ 1U 19" Horizontal organizer with 5 metal hooks and cable entrance slots



▶ 1/2U 19" Brushed Cable Organizer



▶ 1U 19" Brushed Cable Organizer

CABLE ORGANIZERS

Product Code	Product Description	Width (W) (mm)	Depth (D) (mm)	Height (H) (mm)	Weight (Kg)
PA CC ORG YO 1U	1U 19" Horizontal Organizer Metal Hooks	483	80	44	0,50
PA CC ORG YO 2U	2U 19" Horizontal Organizer Metal Hooks	483	80	88	0,80
PA CC ORG YOD 1U	1U 19" Horizontal Organizer Metal Hooks - Slots	483	80	44	0,40
PA CC ORG YOD 2U	2U 19" Horizontal Organizer Metal Hooks - Slots	483	80	88	0,70
PA CC ORG FRP 1U	1U 19" Brushed Cable Organizer	483	100	44	0,80
PA CC ORG KDF 1U	1U 19" Brushed Cable Organizer	483	120	44	0,90
PA CC ORG KDF YU	1/2U 19" Brushed Cable Organizer	483	120	22	0,45

**CC Means=Color Code, BL=Rail 9005 Black, LG=Rail 7035 Light Gray

HORIZONTAL CABLE ORGANIZERS

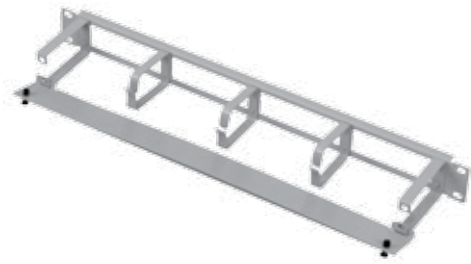

1U 19" Covered Horizontal Organizer with metal hook

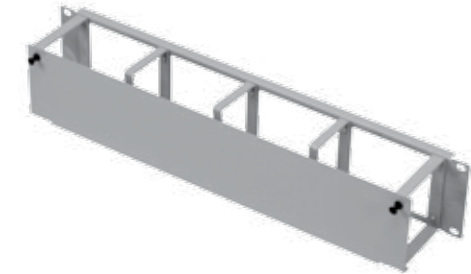

2U 19" Covered Horizontal Organizer with metal hook

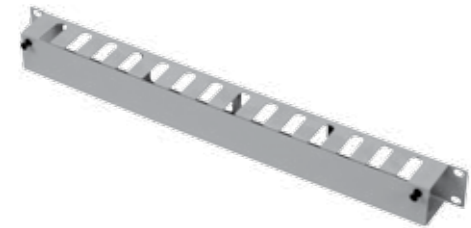

1U 19" Covered Horizontal Organizer

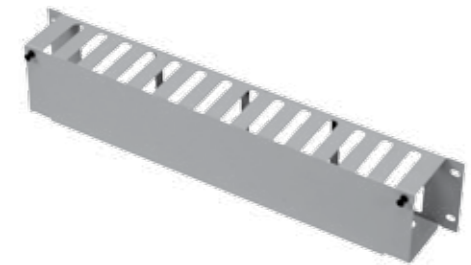

2U 19" Covered Horizontal Organizer

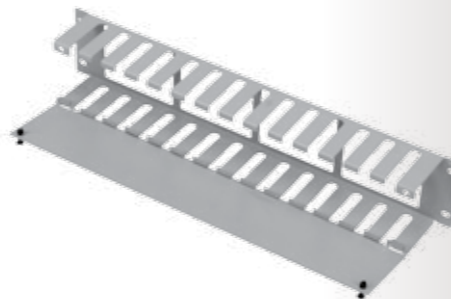
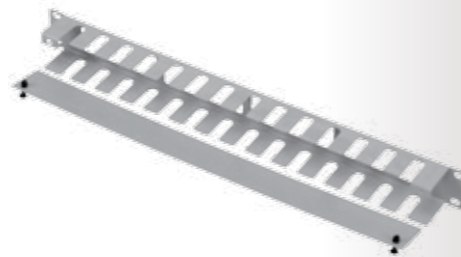
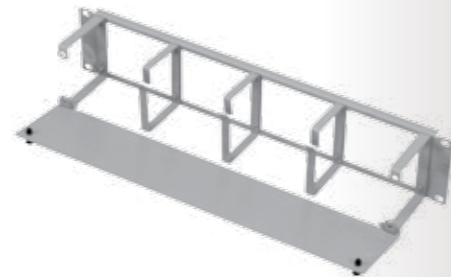
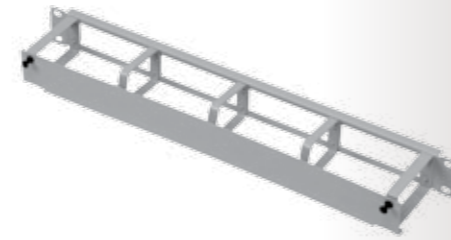

HORIZONTAL CABLE ORGANIZERS



1U 19" Horizontal Organizers with 5 plastic hook



Metal Cable Management Hook

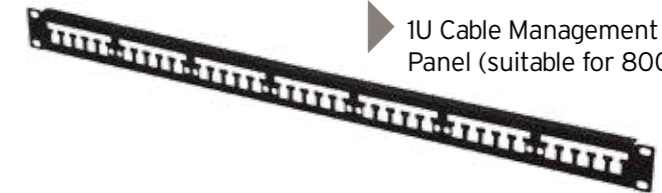

1U Cable Management Panel (suitable for 800mm depth)

1U 19" Cable Management Panel

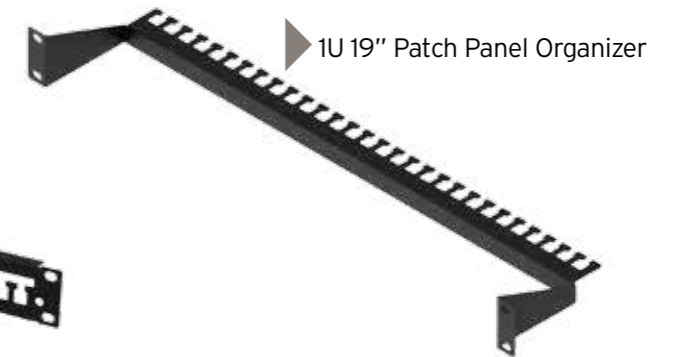

1U 19" Patch Panel Organizer

HORIZONTAL ORGANIZERS

Product Code	Product Description	Width (W) (mm)	Depth (D) (mm)	Height (H) (mm)	Weight (Kg)
PA CC ORG KYOK 1U	1U 19" Covered Horizontal Organizer With Metal Hook	483	80	44	0,70
PA CC ORG KYOK 2U	2U 19" Covered Horizontal Organizer With Metal Hook	483	80	88	0,90
PA CC ORG KYOT 1U	1U 19" Covered Horizontal Organizer	483	80	44	0,50
PA CC ORG KYOT 2U	2U 19" Covered Horizontal Organizer	483	80	88	0,90

**CC Means=Color Code, BL=Rail 9005 Black, LG=Rail 7035 Light Gray

HORIZONTAL ORGANIZERS

Product Code	Product Description	Width (W) (mm)	Depth (D) (mm)	Height (H) (mm)	Weight (Kg)
PA CC ORG YOPK 1U	1U 19" Horizontal Organizers With 5 Plastic Hook	483	80	44	0,40
PA CC ORG YOPK 2U	2U 19" Horizontal Organizers With 10 Plastic Hook	483	80	88	0,60
PA CC ORG KDTR 1U	1U 19" Cable Management Hook	483	10	44	0,10
PA CC ORG KDTR 1U 80	1U Cable Management Panel (Suitable For 800mm Depth Cabinet)	468	10	44	0,30
PA CC ORG KDTR 1U 10	1U Cable Management Panel (Suitable For 600mm Depth Cabinet)	668	10	44	0,20
PA CC ORG KDK	1U Metal Cable Management Hook	44	20	70	0,30
PA CC ORG PPO 1U	1U 19" Patch Panel Organizer	483	110	44	0,20

**CC Means=Color Code, BL=Rail 9005 Black, LG=Rail 7035 Light Gray

VERTICAL CABLE ORGANIZERS



VERTICAL ORGANIZERS

Product Code	Product Description	Width (W) (mm)	Depth (D) (mm)	Height (H) (mm)	Weight (Kg)
PA CC ORG 16 V	16U Vertical Cable Organizer	100	100	630	5,50
PA CC ORG 20 V	20U Vertical Cable Organizer	100	100	808	7,00
PA CC ORG 22 V	22U Vertical Cable Organizer	100	100	897	8,00
PA CC ORG 26 V	26U Vertical Cable Organizer	100	100	1120	10,00
PA CC ORG 32 V	32U Vertical Cable Organizer	100	100	1340	12,00
PA CC ORG 36 V	36U Vertical Cable Organizer	100	100	1518	13,00
PA CC ORG 42 V	42U Vertical Cable Organizer	100	100	1878	15,00
PA CC ORG 45 V	44U Vertical Cable Organizer	100	100	1918	16,00
PA CC ORG 47 V	47U Vertical Cable Organizer	100	100	2007	17,50

Vertical cable management panels are suitable only for w: 800 mm cabinet. 1set 2pcs Left/Right

VERTICAL CABLE ORGANIZERS



VERTICAL ORGANIZER WITH SLIDING RAILS AND COVERED

Ürün Kodu	Product Description	Width (W) (mm)	Depth (D) (mm)	Height (H) (mm)	Weight (Kg)
PA CC ORG 16 VOT	16U Vertical Organizer With Sliding Rails And Covered	60	70	661	1,00
PA CC ORG 20 VOT	20U Vertical Organizer With Sliding Rails And Covered	60	70	840	1,20
PA CC ORG 22 VOT	22U Vertical Organizer With Sliding Rails And Covered	60	70	928	1,30
PA CC ORG 26 VOT	26U Vertical Organizer With Sliding Rails And Covered	60	70	1106	1,60
PA CC ORG 32 VOT	32U Vertical Organizer With Sliding Rails And Covered	60	70	1372	2,00
PA CC ORG 36 VOT	36U Vertical Organizer With Sliding Rails And Covered	60	70	1550	2,20
PA CC ORG 42 VOT	42U Vertical Organizer With Sliding Rails And Covered	60	70	1816	2,60
PA CC ORG 45 VOT	44U Vertical Organizer With Sliding Rails And Covered	60	70	1905	2,70
PA CC ORG 47 VOT	47U Vertical Organizer With Sliding Rails And Covered	60	70	2039	2,90

VERTICAL CABLE TRAYS

Product Code	Product Description	Width (W) (mm)	Depth (D) (mm)	Height (H) (mm)	Weight (Kg)
PA GL ORG 16 VCT	16U Vertical Cable Tray	100	10	720	10,20
PA GL ORG 20 VCT	20U Vertical Cable Tray	100	10	892	12,80
PA GL ORG 22 VCT	22U Vertical Cable Tray	100	10	981	14,00
PA GL ORG 26 VCT	26U Vertical Cable Tray	100	10	1159	16,80
PA GL ORG 32 VCT	32U Vertical Cable Tray	100	10	1426	20,80
PA GL ORG 36 VCT	36U Vertical Cable Tray	100	10	1600	23,50
PA GL ORG 42 VCT	42U Vertical Cable Tray	100	10	1870	27,50
PA GL ORG 45 VCT	44U Vertical Cable Tray	100	10	2003	28,80
PA GL ORG 47 VCT	47U Vertical Cable Tray	100	10	2092	30,80

BLANK PANELS



▶ 1U Blank Panel - Solid

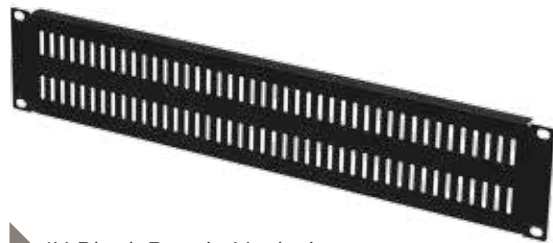

▶ 1U Blank Panel - Vented

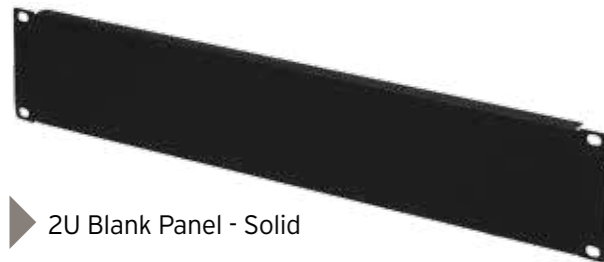

▶ 2U Blank Panel - Solid

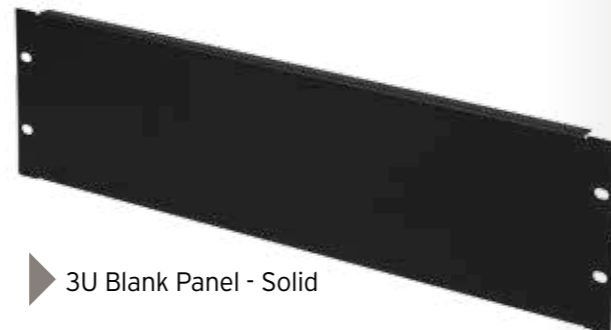

▶ 3U Blank Panel - Solid

- Designed for preventing air recirculation by occupying unused rack space.
- 19" Rack mountable, solid or vented type

Color Options

- RAL 9005 - Black (Standard)
- RAL 7035 - White (Optional)

BLANK PANELS

Product Code	Product Description	Width (W) (mm)	Depth (D) (mm)	Height (H) (mm)	Weight (Kg)
PA CC RK KP 01	1U 19" Blank Panel	483	12	44	0,30
PA CC RK KP 02	2U 19" Blank Panel	483	12	88	0,50
PA CC RK KP 03	3U 19" Blank Panel	483	12	133	0,70
PA CC RK KP 04	4U 19" Blank Panel	483	12	177	0,90
PA CC RK KP 05	5U 19" Blank Panel	483	12	221,5	1,10
PA CC RK KP 06	6U 19" Blank Panel	483	12	266	1,30
PA CC RK KPD 01	1U 19" Blank Panel-Vented	483	12	44	0,30
PA CC RK KPD 02	2U 19" Blank Panel-Vented	483	12	88	0,50

**CC Means=Color Code, BL=Rall 9005 Black, LG=Rall 7035 Light Gray

CASTORS & LEVELLING FEETS

- Polyamid wheels
- 360° Rotatable
- One set include 2 pcs castors with brake and 2 pcs without brake
- Leveling feets made from metal and PVC



CASTER SET & LEVELLING FEETS

Product Code	Product Description	Width (W) (mm)	Depth (D) (mm)	Height (H) (mm)	Load Carrying Capacity (unit/kg)	Weight (Kg)
PA 00 FS TK 22	Castor Levelling Group 2 ea.lockable,rotatable	80	90	80	150	2,20
PA 00 WL TK 22	Wall Mounted Cabinets Castor Group 2 ea.lockable,rotatable	80	50	70	100	1,00
PA 00 KR PN 00	Levelling feet for cabinets (M10)	45	-	100	250	0,30

**CC Means=Color Code, BL=Rall 9005 Black, LG=Rall 7035 Light Gray

PLINTH



► Plinth - Solid

- Designed for increasing of height distance between floor and rack and/or fixing onto floor and/or provide empty area for cable reserve and/or passive air ventilation.
- There are 3 types, solid, brushed or louvered.

Color Options

- RAL 9005 - Black (Standard)
- RAL 7035 - White (Optional)



► Plinth - Brushed



► Plinth - Louvered

PLINTH

Product Code	Product Description	Width (W) (mm)	Depth (D) (mm)	Height (H) (mm)	Weight (Kg)
PA CC BZ 66	600 mm x 600 mm Plinth - Solid	600	600	110	6,50
PA CC BZ 68	600 mm x 800 mm Plinth - Solid	600	800	110	7,50
PA CC BZ 88	600 mm x 1000 mm Plinth - Solid	800	800	110	8,50
PA CC BZ 61	800 mm x 800 mm Plinth - Solid	600	800	110	8,50
PA CC BZ 81	800 mm x 1000 mm Plinth - Solid	800	1000	110	9,50
PA CC BZ 66 F	600 mm x 600 mm Plinth - Brushed	600	600	110	6,50
PA CC BZ 68 F	600 mm x 800 mm Plinth - Brushed	600	800	110	7,50
PA CC BZ 61 F	600 mm x 1000 mm Plinth - Brushed	600	1000	110	8,50
PA CC BZ 88 F	800 mm x 800 mm Plinth - Brushed	800	800	110	8,50
PA CC BZ 81 F	800 mm x 1000 mm Plinth - Brushed	800	1000	110	9,50
PA CC BZ 66 P	600 mm x 600 mm Plinth - Louvered	600	600	110	6,50
PA CC BZ 68 P	600 mm x 800 mm Plinth - Louvered	600	800	110	7,50
PA CC BZ 61 P	600 mm x 1000 mm Plinth - Louvered	600	1000	110	8,50
PA CC BZ 88 P	800 mm x 800 mm Plinth - Louvered	800	800	110	8,50
PA CC BZ 81 P	800 mm x 1000 mm Plinth - Louvered	800	1000	110	9,50

**CC Means=Color Code, BL=Rall 9005 Black, LG=Rall 7035 Light Gray

FLOOR FIXING BRACKET

- Designed for fixing of floor standing racks onto floor.
- It's also provide roll-over protection.
- It's made of steel and bracket length is based on rack width.
- Set include 1 pair of L bracket.

Color Options

- RAL 9005 - Black (Standard)
- RAL 7035 - White (Optional)

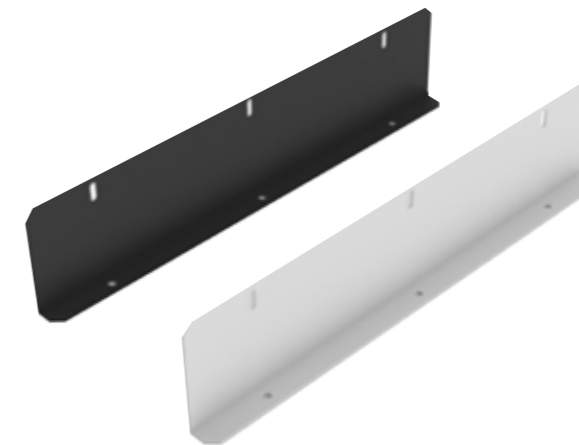

W600 Floor Fixing Bracket



W800 Floor Fixing Bracket

FLOOR FIXING KIT

Product Code	Product Description	Width (W) (mm)	Depth (D) (mm)	Height (H) (mm)	Weight (Kg)
PA CC DBK W60	W600 Floor Fixing Kit	500	27,5	107,5	1,00
PA CC DBK W80	W800 Floor Fixing Kit	700	27,5	107,5	1,50

**CC Means=Color Code, BL=Rall 9005 Black, LG=Rall 7035 Light Gray

FAN MODULES

Designed for floor standing and wall mount cabinets. Provides forced air ventilation by axial ball bearing fansthat silent (max. 47dBA) and high volume (2.3 - 3.0 m3/min)

and long life.

Analog or digital thermostat provide managing of operating temperature set up values inside of the rack (0-35°C)



WALL MOUNTING TYPE FAN MODULES

Product Code	Product Description	Width (W) (mm)	Depth (D) (mm)	Height (H) (mm)	Weight (Kg)
PA CC WL FN 01	Fan Modules; 1 Fan,with On/Off switch control	340	190	40	1,40
PA CC WL FN 02	Fan Modules; 2 Fan,with On/Off switch control	340	190	40	1,80
PA CC WL FN T1	Fan Modules; 1 Fan,with Analog thermostat control unit	340	190	74	1,50
PA CC WL FN T2	Fan Modules; 2 Fan,with Analog thermostat control unit	340	190	74	1,90
PA CC WL FN DT1	Fan Modules; 1 Fan,with Digital thermostat control unit	340	190	74	1,50
PA CC WL FN DT2	Fan Modules; 2 Fan,with Digital thermostat control unit	340	190	74	1,90



19" RACK MOUNT FAN MODULES

Product Code	Product Description	Width (W) (mm)	Depth (D) (mm)	Height (H) (mm)	Weight (Kg)
PA CC RK FN 02	1U 19" Rack Mount 2 fans with On/Off switch control	483	320	40	2,90
PA CC RK FN 04	1U 19" Rack Mount 4 fans with On/Off switch control	483	320	40	3,70
PA CC RK FN T2	1U 19" Rack Mount 2 fans+Analog Thermostat	483	320	74	3,00
PA CC RK FN T4	1U 19" Rack Mount 4 fans+Analog Thermostat	483	320	74	3,80
PA CC RK FN DT2	1U 19" Rack Mount 2 fans+Digital Thermostat	483	320	74	3,00
PA CC RK FN DT4	1U 19" Rack Mount 4 fans+Digital Thermostat	483	320	74	3,80

**CC Means=Color Code, BL=Rall 9005 Black, LG=Rall 7035 Light Gray

FAN MODULES

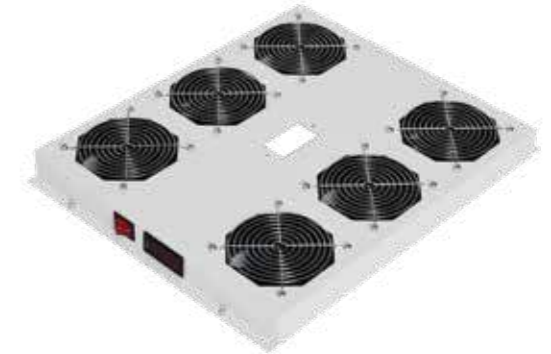
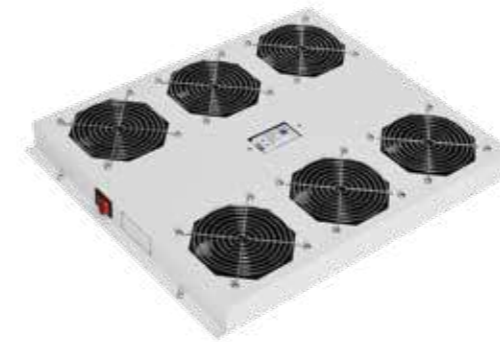

FREE STANDING - ELEGANT NET / PRO & SERVER RACK

Product Code	Product Description	Width (W) (mm)	Depth (D) (mm)	Height (H) (mm)	Ağırlık (Kg)
PA CC ELG FN 02	Ventilation unit with 2 Fans+with On/Off switch control	400	400	40	2,70
PA CC ELG FN 04	Ventilation unit with 4 Fans+with On/Off switch control	400	400	40	3,80
PA CC ELG FN 06	Ventilation unit with 6 Fans+with On/Off switch control (For depth 1000mm cabinets)	400	550	40	5,30
PA CC SV RDFN 06	Rear door Ventilation unit with 6 Fans+with On/Off switch control	-	-	-	12,00
PA CC SV RDFN 12	Rear door Ventilation unit with 12 Fans+with On/Off switch control	-	-	-	24,00
PA CC ELG FN T2	Ventilation unit with 2 Fans+Analog Thermostat	400	400	40	2,80
PA CC ELG FN T4	Ventilation unit with 4 Fans+Analog Thermostat	400	400	40	3,90
PA CC ELG FN T6	Ventilation unit with 6 Fans+Analog Thermostat (Only for D:1000mm cabinets)	400	550	40	5,40
PA CC SV RDFN T6	Rear door Ventilation unit with 6 Fans+Analog Thermostat	-	-	-	12,10
PA CC SV RDFN T12	Rear door Ventilation unit with 12 Fans+Analog Thermostat	-	-	-	24,10
PA CC ELG FN DT2	Ventilation unit with 2 Fans+Digital Thermostat	400	400	40	2,80
PA CC ELG FN DT4	Ventilation unit with 4 Fans+Digital Thermostat	400	400	40	3,90
PA CC ELG FN DT6	Ventilation unit with 6 Fans+Digital Thermostat (Only for D:1000mm cabinets)	400	550	40	5,40
PA CC SV RDFN DT6	Rear door Ventilation unit with 6 Fans+Digital Thermostat	-	-	-	12,10
PA CC SV RDFN DT12	Rear door Ventilation unit with 12 Fans+Digital Thermostat	-	-	-	24,10
PA 00 SG	Digital heat screen				

**CC Means=Color Code, BL=Rall 9005 Black, LG=Rall 7035 Light Gray

ALUMINUM BODY PDU MODULES

The compact aluminum profile structure provides wide alternative plug types for customer needs. It could use as 19" 1U horizontal and up to 47U as vertical.

Optional socket type: Schuko, French, UK, C13, C19 and others
Optional plug type: Schuko, French, UK, C14, C20 and others

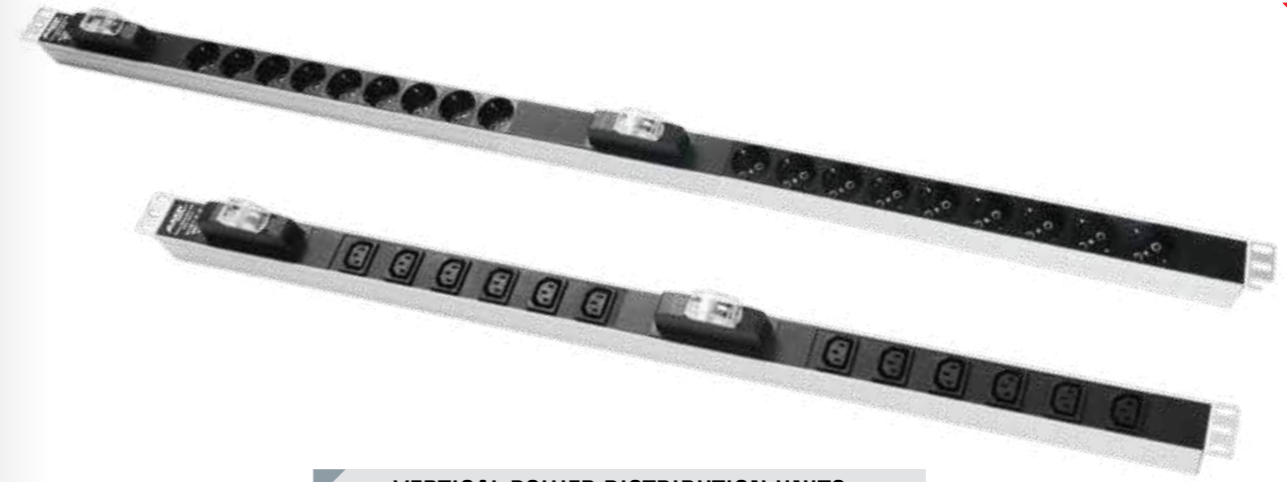

HORIZONTAL POWER DISTRIBUTION UNITS

SCHUKO TYPE - HORIZONTAL POWER DISTRIBUTION UNITS WITH CIRCUIT BREAKER

Product Code	Product Description	Width (W) (mm)	Depth (D) (mm)	Height (H) (mm)	Weight (Kg)
PA AL SCH CB03	1U 3 way power strip, 19" Aluminium profile, schuko type plug, 250vac, 1ea 16A circuit breaker 3.5kW, 2m power cord 3x1.5mm ² cable	483	44	44	0.70
PA AL SCH CB06	1U 6 way power strip, 19" Aluminium profile, schuko type plug, 250vac, 1ea 16A circuit breaker 3.5kW, 2m power cord 3x1.5mm ² cable	483	44	44	0.85
PA AL SCH CB09	2U 9 way power strip, 19" Aluminium profile, schuko type plug, 250vac, 1ea 16A circuit breaker 3.5kW, 2m power cord 3x1.5mm ² cable	483	44	44	1.30
PA AL SCH CB12	2U 12 way power strip, 19" Aluminium profile, schuko type plug, 250vac, 1ea 16A circuit breaker 3.5kW, 2m power cord 3x1.5mm ² cable	483	44	44	1.50
PA AL SCH DCB09	2U 9 way power strip, 19" Aluminium profile, schuko type plug, 250vac, 2x16A Dual circuit breaker 3.5kW, 2m power cord 3x1.5mm ² cable	483	44	44	1.50
PA AL SCH DCB12	2U 12 way power strip, 19" Aluminium profile, schuko type plug, 250vac, 2x16A Dual circuit breaker 3.5kW, 2m power cord 3x1.5mm ² cable	483	44	44	1.70

SCHUKO TYPE - HORIZONTAL POWER DISTRIBUTION UNITS WITH ON/OFF SWITCH

Product Code	Product Description	Width (W) (mm)	Depth (D) (mm)	Height (H) (mm)	Weight (Kg)
PA AL SCH SW03	1u 3 way power strip 19" Aluminium profile, schuko type plug 250vac, On/Off switch 2m power cord 3x1.5mm ² cable	483	44	44	0.65
PA AL SCH SW06	1u 6 way power strip 19" Aluminium profile, schuko type plug 250vac, On/Off switch 2m power cord 3x1.5mm ² cable	483	44	44	0.80
PA AL SCH SW08	1u 8 way power strip 19" Aluminium profile, schuko type plug 250vac, On/Off switch 2m power cord 3x1.5mm ² cable	483	44	44	0.90

IEC 320 / C13 TYPE - HORIZONTAL POWER DISTRIBUTION UNITS WITH CIRCUIT BREAKER

Product Code	Product Description	Width (W) (mm)	Depth (D) (mm)	Height (H) (mm)	Weight (Kg)
PA AL IEC CB06	1U 6 way power strip, 19" Aluminium profile, IEC320 type socket, 250vac, 1ea 16A circuit breaker 3.5kW, 2m power cord 3x1.5mm ² cable	483	44	44	0.80
PA AL IEC CB09	2U 9 way power strip, 19" Aluminium profile, IEC320 type socket, 250vac, 1ea 16A circuit breaker 3.5kW, 2m power cord 3x1.5mm ² cable	483	44	44	0.85
PA AL IEC CB12	2U 12 way power strip, 19" Aluminium profile, IEC320 type socket, 250vac, 1ea 16A circuit breaker 3.5kW, 2m power cord 3x1.5mm ² cable	483	44	44	1.30
PA AL IEC DCB09	2U 9 way power strip, 19" Aluminium profile, IEC320 type socket, 250vac, 2x16A Dual circuit breaker 3.5kW, 2m power cord 3x1.5mm ² cable	483	44	44	1.40
PA AL IEC DCB12	2U 12 way power strip, 19" Aluminium profile, IEC320 type socket, 250vac, 2x16A Dual circuit breaker 3.5kW, 2m power cord 3x1.5mm ² cable	483	44	44	1.50
PA AL IEC CB06SC	2U 12 way power strip, 19" Aluminium profile, IEC320 type socket, 250vac, 2x16A Dual circuit breaker 3.5kW, 2m power cord 3x1.5mm ² cable with Ampermeter screen	483	44	44	0.90

IEC 320 / C13 TYPE - HORIZONTAL POWER DISTRIBUTION UNITS WITH ON/OFF SWITCH CONTROL

Product Code	Product Description	Width (W) (mm)	Depth (D) (mm)	Height (H) (mm)	Weight (Kg)
PA AL IEC SW06	1U 6 way power strip, 19" Aluminium profile, IEC320 type socket, 250vac, On/Off switch, 2m power cord 3x1.5mm ² cable	483	44	44	0.70
PA AL IEC SW09	2U 9 way power strip, 19" Aluminium profile, IEC320 type socket, 250vac, On/Off switch, 2m power cord 3x1.5mm ² cable	483	44	44	0.80
PA AL IEC SW12	2U 12 way power strip, 19" Aluminium profile, IEC320 type socket, 250vac, On/Off switch, 2m power cord 3x1.5mm ² cable	483	44	44	1.25

UK TYPE POWER DISTRIBUTION UNITS WITH ON/OFF SWITCH CONTROL

Product Code	Product Description	Width (W) (mm)	Depth (D) (mm)	Height (H) (mm)	Weight (Kg)
PA 02 UK SW06	1U 6 way power strip, 19" Aluminium profile, UK type socket, 250vac, On/Off switch, 2m power cord 3x1.5mm ² cable	483	44	44	0.80



VERTICAL POWER DISTRIBUTION UNITS

SCHUKO TYPE - VERTICAL POWER DISTRIBUTION UNITS WITH CIRCUIT BREAKER

Product Code	Product Description	Width (W) (mm)	Depth (D) (mm)	Height (H) (mm)	Weight (Kg)
PA AL SCH DCB1842	42U 18 way power strip, Vertical Aluminium profile, schuko type plug, 250vac, 2x16A Dual circuit breaker 3.5kW, 2m power cord 3x1.5mm ² cable	44	44	1600	2.50
PA AL SCH DCB1836	36U 18 way power strip, Vertical Aluminium profile, schuko type plug, 250vac, 2x16A Dual circuit breaker 3.5kW, 2m power cord 3x1.5mm ² cable	44	44	1333	2.30
PA AL SCH DCB1226	26U 12 way power strip, Vertical Aluminium profile, schuko type plug, 250vac, 2x16A Dual circuit breaker 3.5kW, 2m power cord 3x1.5mm ² cable	44	44	889	2.15
PA AL SCH DCB2442	42U 24 way power strip, Vertical Aluminium profile, schuko type plug, 250vac, 2x16A Dual circuit breaker 3.5kW, 2m power cord 3x1.5mm ² cable	44	44	1600	2.50

IEC 320 / C13 TYPE - VERTICAL POWER DISTRIBUTION UNITS WITH CIRCUIT BREAKER

Product Code	Product Description	Width (W) (mm)	Depth (D) (mm)	Height (H) (mm)	Weight (Kg)
PA AL IEC DCB1842	42U 18 way power strip, Vertical Aluminium profile, IEC320 type socket, 250vac, 2x16A Dual circuit breaker 3.5kW, 2m power cord 3x1.5mm ² cable	44	44	1600	2.30
PA AL IEC DCB1836	36U 18 way power strip, Vertical Aluminium profile, IEC320 type socket, 250vac, 2x16A Dual circuit breaker 3.5kW, 2m power cord 3x1.5mm ² cable	44	44	1333	2.15
PA AL IEC DCB1226	26U 12 way power strip, Vertical Aluminium profile, IEC320 type socket, 250vac, 2x16A Dual circuit breaker 3.5kW, 2m power cord 3x1.5mm ² cable	44	44	889	2.15
PA AL IEC DCB2442	42U 24 way power strip, Vertical Aluminium profile, IEC320 type socket, 250vac, 2x16A Dual circuit breaker 3.5kW, 2m power cord 3x1.5mm ² cable	44	44	1600	2.50
PA AL IEC DCB2442SC	42U 24 way power strip, Vertical Aluminium profile, IEC320 type socket, 250vac, 2x16A Dual circuit breaker 3.5kW, 2m power cord 3x1.5mm ² cable with Ampermeter screen	44	44	1600	2.70



Designed for lighting inside of racks. It could be rack mountable or with magnetic mechanism. Also manage with door switch or on/off switch too.

LIGHTING MODULES

Product Code	Product Description	Width (W) (mm)	Depth (D) (mm)	Height (H) (mm)	Weight (Kg)
PA AL AYDNL A	Lighting Module on/off switch	483	44	22	0.60
PA AL AYDNL S	Lighting Module with door switch	483	44	22	0.65

L - TYPE SUPPORTER BRACKET



L type brackets are used when equipment mounted to the front rails needs additional weight support. Easy mountable and load carrying capacity is 100kgs. Made from zinc plated steel and 1 set includes 1 pair brackets.

Finishing

TS-914 Galvanized Sheet Steel

L TYPE SUPPORTER BRACKET

Product Code	Product Description	Width (W) (mm)	Depth (D) (mm)	Height (H) (mm)	Weight (Kg)
PA GL LTCDP D60	L Type Supporter Bracket D: 600 mm Depth Cabinets	60	280	44	0,30
PA GL LTCDP D80	L Type Supporter Bracket D: 800 mm Depth Cabinets	60	480	44	0,60
PA GL LTCDP D10	L Type Supporter Bracket D: 1000 mm Depth Cabinets	60	680	44	0,80

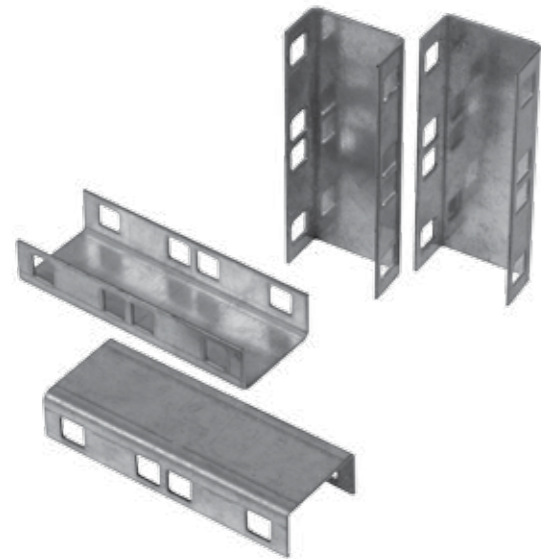

BAYING KIT

Designed for baying of chassis together without side panels. Each kit include 4 pcs U type brackets.

Finishing

TS-914 Galvanized Sheet Steel

BAYING KIT

Product Code	Product Description	Width (W) (mm)	Depth (D) (mm)	Height (H) (mm)	Weight (Kg)
PA GL KBK	Baying Kit	38	19	100	0,10

21" to 19" CONVERTER BRACKET

Designed for 19" equipment mountings to 21" racks. Made from steel and 1 set includes 2 bracket.

Finishing

TS-914 Galvanized Sheet Steel

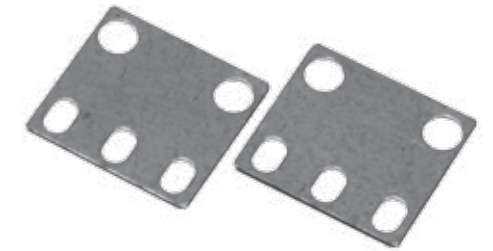

Product Code	Product Description	Width (W) (mm)	Depth (D) (mm)	Height (H) (mm)	Weight (Kg)
PA CC 21 19BP	1U 21" to 19" Converter Bracket	40	-	44	0,10
PA CC 21 19BP 2U	2U 21" to 19" Converter Bracket	40	-	44	0,20

FASTENER SETS

- M6x15mm Cross Recessed Pan Head Screw
- M6 Cage Nut
- Plastic washer

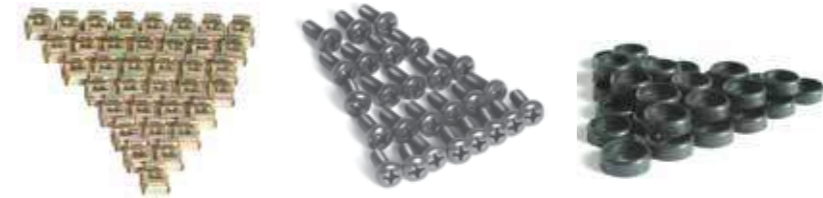

Product Code	Product Description	Weight (Kg)
PA 00 RK KS M6-20	M6 Cage Nut Midi Set (1 set=20pcs cage nut, screw and washer)	0,10
PA 00 RK KS M6-50	M6 Cage Nut Maxi Set (1 set=50pcs cage nut, screw and washer)	0,10
PA 00 RK KS M6-4	M6 Cage Nut Mini Set (1 set=4ea cage nut, screw and washer)	0,30

GROUNDING KIT

- Designed for providing of grounding continuity.
- 1 set includes 2pcs 50cm, 2pcs 80cm 2.5mm grounding cable with terminals, 2pcs isolator, 1 pcs copper busbar with 4 connection point.

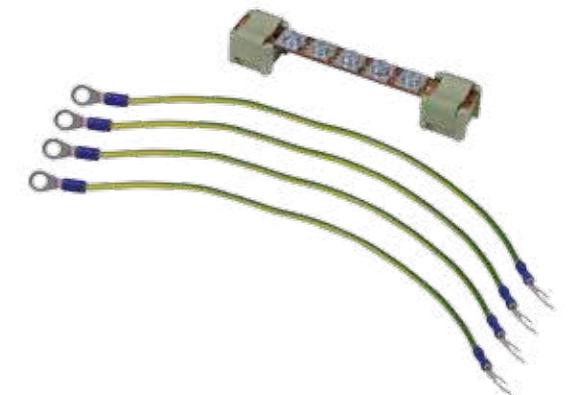

Product Code	Product Description	Weight (Kg)
PA 00 TPK 01	Grounding kit 6ea.earthing leads+copper busbar	0,20

PATCH BRACKET

It is easy and economic solutions to fix onto wall for 19" rack mountable active or passive equipment. Load carrying capacity is 15kgs and changeable depth is extra features.

Color Options

- RAL 9005 - Black (Standard)
- RAL 7035 - White (Optional)

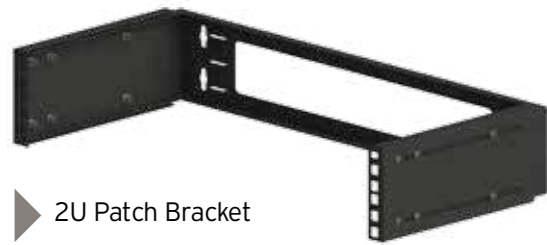

2U Patch Bracket

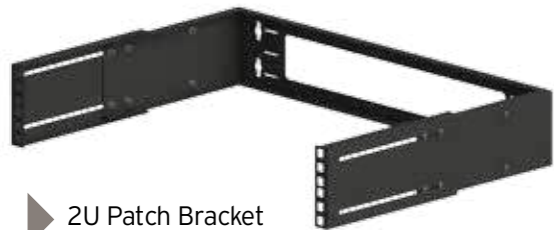

2U Patch Bracket (Open)

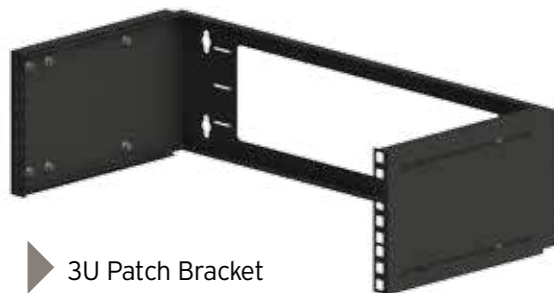

3U Patch Bracket

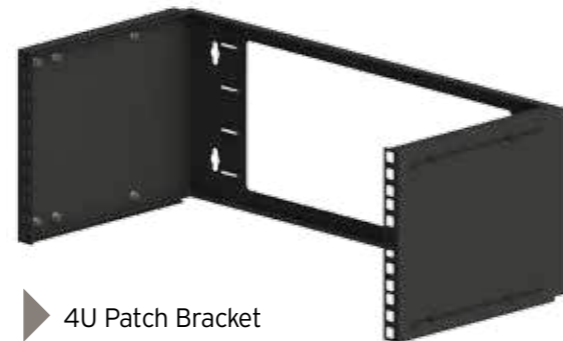

4U Patch Bracket

PATCH BRACKET

Product Code	Product Description	Width (W) (mm)	Depth (D) (mm)	Height (H) (mm)	Weight (Kg)
PA CC PB 2U	2U 19" Patch Bracket	490	220 - 350	92	1,50
PA CC PB 3U	3U 19" Patch Bracket	490	220 - 350	137	2,00
PA CC PB 4U	4U 19" Patch Bracket	490	220 - 350	181	2,50

**CC Means=Color Code, BL=Rall 9005 Black, LG=Rall 7035 Light Gray

TELEPHONE DISTRIBUTION BOX

Designed for providing easy and sturdy termination of telecom cables inside and assembling of termination blocks. Also includes stainless steel frame for terminal block. It could be use as rack mountable and/or wall mountable.

Color Options

- RAL 9005 - Black (Standard)
- RAL 7035 - White (Optional)

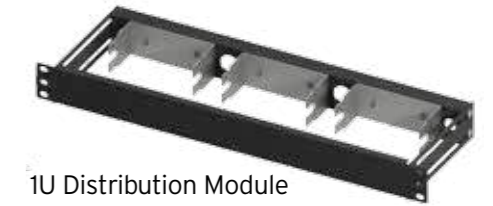

1U Distribution Module

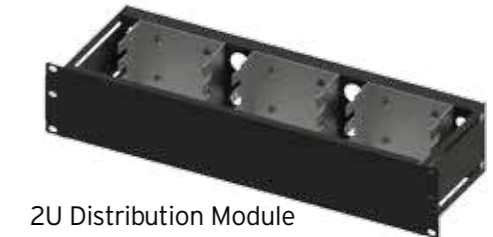
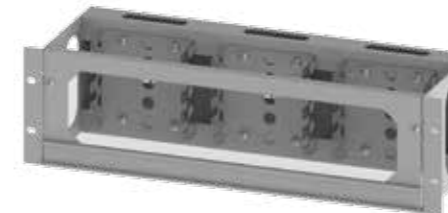

2U Distribution Module

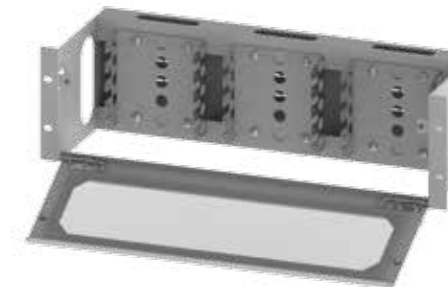

9U Distribution Module



TELEPHONE DISTRIBUTION BOX

Product Code	Product Description	Width (W) (mm)	Depth (D) (mm)	Height (H) (mm)	Weight (Kg)
PA CC RC 1U	1U Telephone Distribution Module - 60 Pair (2 X 3)	483	150	44	1,40
PA CC RC 2U	2U Telephone Distribution Module - 120 Pair (4 X 3)	483	150	88	2,20
PA CC RC 9U	9U Telephone Distribution Module - 510 Pair (17 X 3)	483	150	400	7,80
PA CC TDP 3U	3U Telephone Distribution Module - 150 Pair (5 X 3)	483	150	133	2,80

**CC Means=Color Code, BL=Rall 9005 Black, LG=Rall 7035 Light Gray

Pro Case



caloimets



PRO-Case Outdoor Cabinet

PRO CASE cabinets offer protection against the unauthorized persons, physical effects and impacts (vandalism) water & dust inlet in according the standards of EN60529, as well as industrial environmental challenges including high temperatures.

Cabinets are available with integrated thermal management using either a fan and filter combination or air conditioner to control internal temperatures for protecting sensitive 19" rack equipment from water and harmful environmental contami-

nants, Ral 7035 light gray epoxy polyester paint provides high corrosion resistance. IP55 Enclosures are employed in the most various environments e.g. Factories, warehouses, industrial areas, railways, Highway, military industry etc.

Fully gasketed front door combined with 3 point locking mechanism for superior security, Also Plastic cable glands are available on the base plate, 2pcs vertical mounting rails are adjustable throughout the entire depth of the enclosure.

STANDARDS;

- TSE-ISO-EN 9001:2008
- TSE EN 61587-1
- EN 61587-1
- EN 62208
- CE (2006/95/EC-2004/108/EC)

PRO-Case
Outdoor Cabinet

W:600mm D:450x600mm



STANDARDS;
TSE-ISO-EN 9001:2008
IEC 60950-1 / EN 60950-1
TSE EN 61587-1
EN 61587-1
EN 62208
CE (2006/95/EC-2004/108/EC)
Protection degree: IP54 to IP66

Ral 7035 light gray epoxy polyester

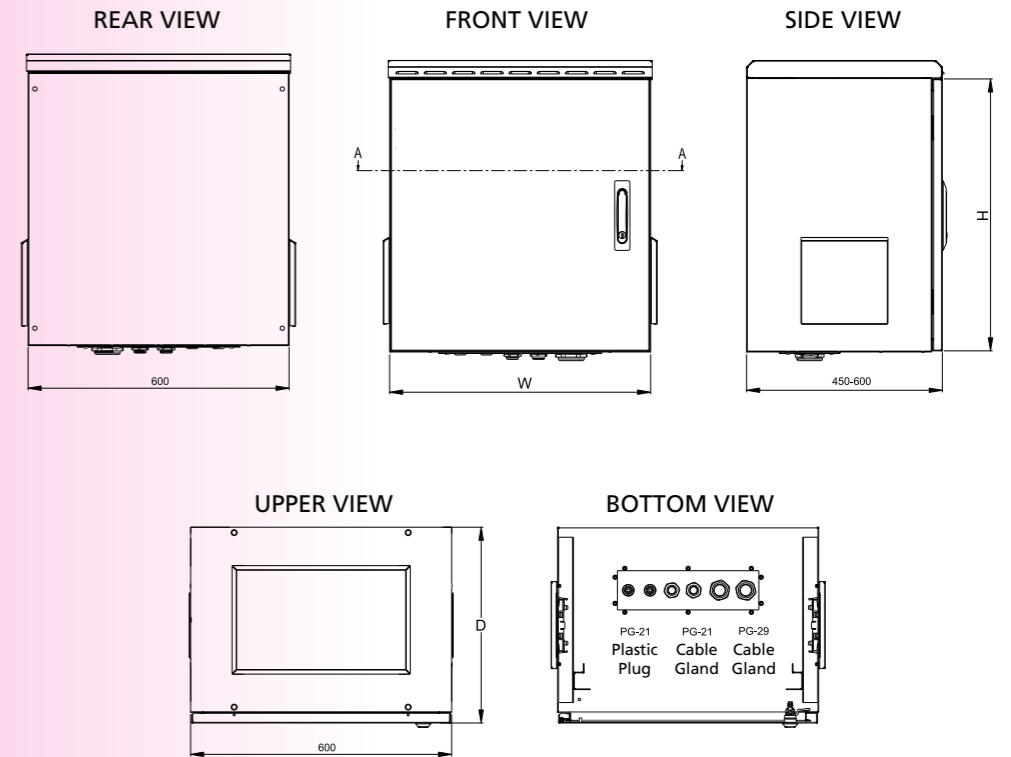

PRO-Case W=600 mm D=450 mm Rack Cabinet

Product Code	Product Description	Width (W) (mm)	Depth (D) (mm)	Height (H) (mm)
PRC 07U 6045 IP55 LG	19" PRO-Case 07U 600x450 IP55 Cabinet	600	450	661
PRC 09U 6045 IP55 LG	19" PRO-Case 09U 600x450 IP55 Cabinet	600	450	840
PRC 12U 6045 IP55 LG	19" PRO-Case 12U 600x450 IP55 Cabinet	600	450	928
PRC 16U 6045 IP55 LG	19" PRO-Case 16U 600x450 IP55 Cabinet	600	450	1106
PRC 20U 6045 IP55 LG	19" PRO-Case 20U 600x450 IP55 Cabinet	600	450	1372
PRC 26U 6045 IP55 LG	19" PRO-Case 26U 600x450 IP55 Cabinet	600	450	1550

PRO-Case W=600 mm D=600 mm Rack Cabinet

Product Code	Product Description	Width (W) (mm)	Depth (D) (mm)	Height (H) (mm)
PRC 07U 6060 IP55 LG	19" PRO-Case 07U 600x600 IP55 Cabinet	600	600	661
PRC 09U 6060 IP55 LG	19" PRO-Case 09U 600x600 IP55 Cabinet	600	600	840
PRC 12U 6060 IP55 LG	19" PRO-Case 12U 600x600 IP55 Cabinet	600	600	928
PRC 16U 6060 IP55 LG	19" PRO-Case 16U 600x600 IP55 Cabinet	600	600	1106
PRC 20U 6060 IP55 LG	19" PRO-Case 20U 600x600 IP55 Cabinet	600	600	1372
PRC 26U 6060 IP55 LG	19" PRO-Case 26U 600x600 IP55 Cabinet	600	600	1550

**CC Means=Color Code, BL=Rail 9005 Black, LG=Rail 7035 Light Gray

PRO-Case
Outdoor Cabinet

Isolation Module

It consist of two different material 1st. Galvanized inner wall 2nd. polythene isolation material, these components are provides high resistance against the climatic changes with support of Fan & filter combination to control internal temperatures inside the enclosure, it is the cost-effective way to eliminate problems that may occur from internal and environmental overheating factors.

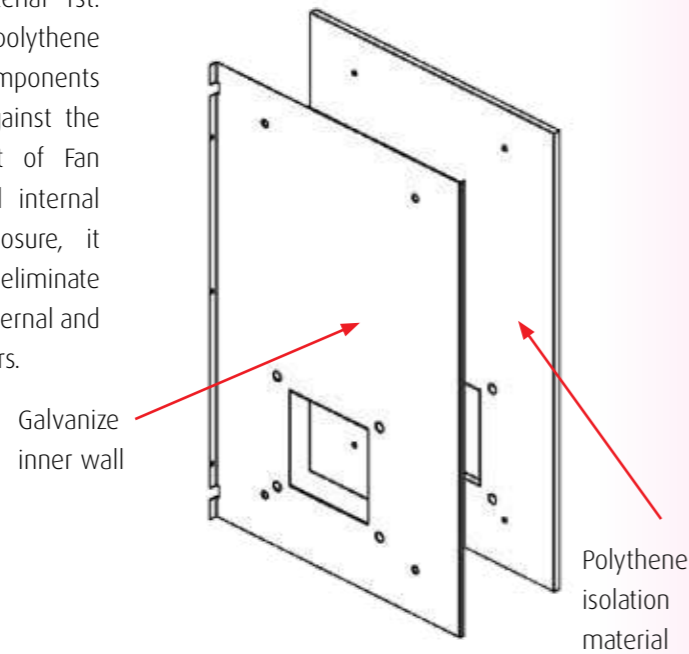

ISOLATION MODULE 600 x 450mm				
Product Code	Product Description	Width (W) (mm)	Depth (D) (mm)	Height (H) (mm)
PRC IZ 07U 6045 PE10	07U 600x450mm isolation module / panel and isolation material	600	450	312
PRC IZ 09U 6045 PE10	09U 600x450mm isolation module / panel and isolation material	600	450	400
PRC IZ 12U 6045 PE10	12U 600x450mm isolation module / panel and isolation material	600	450	534
PRC IZ 16U 6045 PE10	16U 600x450mm isolation module / panel and isolation material	600	450	712
PRC IZ 20U 6045 PE10	20U 600x450mm isolation module / panel and isolation material	600	450	890
PRC IZ 26U 6045 PE10	26U 600x450mm isolation module / panel and isolation material	600	450	1156

ISOLATION MODULE 600 x 600mm				
Product Code	Product Description	Width (W) (mm)	Depth (D) (mm)	Height (H) (mm)
PRC IZ 07U 6060 PE10	07U 600x600mm isolation module / panel and isolation material	600	600	312
PRC IZ 09U 6060 PE10	09U 600x600mm isolation module / panel and isolation material	600	600	400
PRC IZ 12U 6060 PE10	12U 600x600mm isolation module / panel and isolation material	600	600	534
PRC IZ 16U 6060 PE10	16U 600x600mm isolation module / panel and isolation material	600	600	712
PRC IZ 20U 6060 PE10	20U 600x600mm isolation module / panel and isolation material	600	600	890
PRC IZ 26U 6060 PE10	26U 600x600mm isolation module / panel and isolation material	600	600	1156

PRO-Case
Outdoor Cabinet

Plinth

The base/plinth has been developed to simplify installation of outdoor enclosures on the concrete floors, also eliminate risk of the rain & flood in a certain rate, It is also possible to make a great cable storage depending on the base hight.



PLINTH W:600 x D:450				
Product Code	Product Description	Width (W) (mm)	Depth (D) (mm)	Height (H) (mm)
PRC BZ 6045 H10	Plinth 600x450mm H:100mm	600	450	100
PRC BZ 6045 H20	Plinth 600x450mm H:200mm	600	450	200
PRC BZ 6045 H30	Plinth 600x450mm H:300mm	600	450	300
PRC BZ 6045 H40	Plinth 600x450mm H:400mm	600	450	400

BAZA W:600 x D:600				
Product Code	Product Description	Width (W) (mm)	Depth (D) (mm)	Height (H) (mm)
PRC BZ 6060 H10	Plinth 600x600mm H:100mm	600	600	100
PRC BZ 6060 H20	Plinth 600x600mm H:200mm	600	600	200
PRC BZ 6060 H30	Plinth 600x600mm H:300mm	600	600	300
PRC BZ 6060 H40	Plinth 600x600mm H:400mm	600	600	400

PRO-Case
Outdoor Cabinet

Wall-mounting brackets

Wall mounting brackets has been designed for hanging enclosure to the wall, Bracket thickness is 3mm and provides load carrying capacity up to 100kg.



WALL MOUNTING BRACKET

Product Code	Product Description	Width (W) (mm)	Depth (D) (mm)	Height (H) (mm)
PRC DVMA 01	Wall mounting bracket (1 Set 4 pcs.)	600	450	661

Pole-mounting brackets

Pole modules ; Universal type pole module provides ease of use in order to clamping wood or metal poles, it is providing extremely strong clamping on the any height/type poles without need the information of pole dimension or diameter.



POLE MOUNTING BRACKET

Product Code	Product Description	Width (W) (mm)	Depth (D) (mm)	Height (H) (mm)
PRC DRMA 01	Pole-Mounting Bracket - Universal Type	600	450	661

PRO-Case
Outdoor Cabinet

Ventilation Module

Cooling is an extremely important challenge in any networking situation

Ventilation modules which can be detached by removing 4 pcs screws from the top in case of maintenance or replacement needs.

Protect your devices against overheating by choosing the right fan module.

We offer a wide product range of ventilation units with the different fan modules.

On/Off switch Fan modules Analog or digital Thermostat control unit Fan modules. Twin ventilation module with analog thermostat.



FAN MODULE

Product Code	Product Description	Width (W) (mm)	Depth (D) (mm)	Height (H) (mm)
PRC FN T2	2 way ventilation unit with On/off switch and thermostat control	600	450	661

Fiber Optic



caboinets

Fiber Optik Solutions

A lot of fiber optic passive components are needed to reach the speed of light in today's technology in data communications.

Basic design requirements of passive fiberoptic products, an appropriate cable management and unit area ever more cable to be able to fit.

Our main goal is to comply global standards and add extra user friendly functionality on to our design about fiber optical passive products like a splicing box, termination panel and distribution frames.

19" RACK MOUNTING TYPE FIBER OPTIC SPLICE BOXES

Fiber Optik Patch Panel Mechanic Sliding

- 1U height (44mm) and 19" rack mountable structure
- User friendly design
- Cable fixing with PG16 cable glands
- Ready thread for splice tray fastening
- Economic design



19" RACK MOUNTING TYPE FIBER OPTIC SPLICE BOXES

Product Code	Product Description	Width (W) (mm)	Depth (D) (mm)	Height (H) (mm)	Weight (Kg)
1U1924PSTS CC	1U 19" 24 Port ST Simplex Rack Mount Fiber optic splice box	483	230	44	2,4
1U1924PSCS CC	1U 19" 24 Port SC Simplex Rack Mount Fiber optic splice box	483	230	44	2,4
1U1912PSCD CC	1U 19" 12 Port SC Duplex Rack Mount Fiber optic splice box	483	230	44	2,4
1U1924PSCD CC	1U 19" 24 Port SC Duplex Rack Mount Fiber optic splice box	483	230	44	2,4
1U1912PLCD CC	1U 19" 12 Port LC Duplex Rack Mount Fiber optic splice box	483	230	44	2,4
1U1924PFCS CC	1U 19" 24 Port FC Duplex Rack Mount Fiber optic splice box	483	230	44	2,4

**CC Means=Color Code, BL=Rail 9005 Black, LG=Rail 7035 Light Gray

Modular Front Panel With Rail

- 1U height (44mm) and 19" rack mountable structure
- User friendly design
- Cable fixing with PG16 cable glands
- Ready thread for splice tray fastening



19" RACK MOUNT RAIL BOX

Product Code	Product Description	Width (W) (mm)	Depth (D) (mm)	Height (H) (mm)	Weight (Kg)
1U19RYF24PSCS CC	1U 19" 24 Port SC Simplex Rack Mount with rail	483	260	44	3.00
1U19RYF12PSCD CC	1U 19" 12 Port SC Duplex Rack Mount with rail	483	260	44	3.00
1U19RYF24PSTS CC	1U 19" 24 Port ST Simplex Rack Mount with rail	483	260	44	3.00
1U19RYF24PLCD CC	1U 19" 24 Port LC Duplex Rack Mount with rail	483	260	44	3.00
1U19RYF24PFCS CC	1U 19" 24 Port FC Simplex Rack Mount with rail	483	260	44	3.00
1U19RYFMDL CC	1U 19" Fiber Optic Splice Box with rail	483	260	44	3.00
1U19RYF OP 4PSCD CC	Rack Mount Front Panel Modular 4 Port SC Duplex	135	-	38	0,05
1U19RYF OP 8PLCD CC	Rack Mount Front Panel Modular 8 Port LC Duplex	135	-	38	0,05
1U19RYF OP 8PSTS CC	Rack Mount Front Panel Modular 8 Port ST Simplex	135	-	38	0,05
1U19RYF OP K CC	Rack Mount Front Blank Panel Modular	135	-	38	0,05

**CC Means=Color Code, BL=Rail 9005 Black, LG=Rail 7035 Light Gray

Patch Panel with Angled Face Plate

- 1U height (44mm) and 19" rack mountable structure
- User friendly design
- Cable fixing with PG16 cable glands
- Ready thread for splice tray fastening

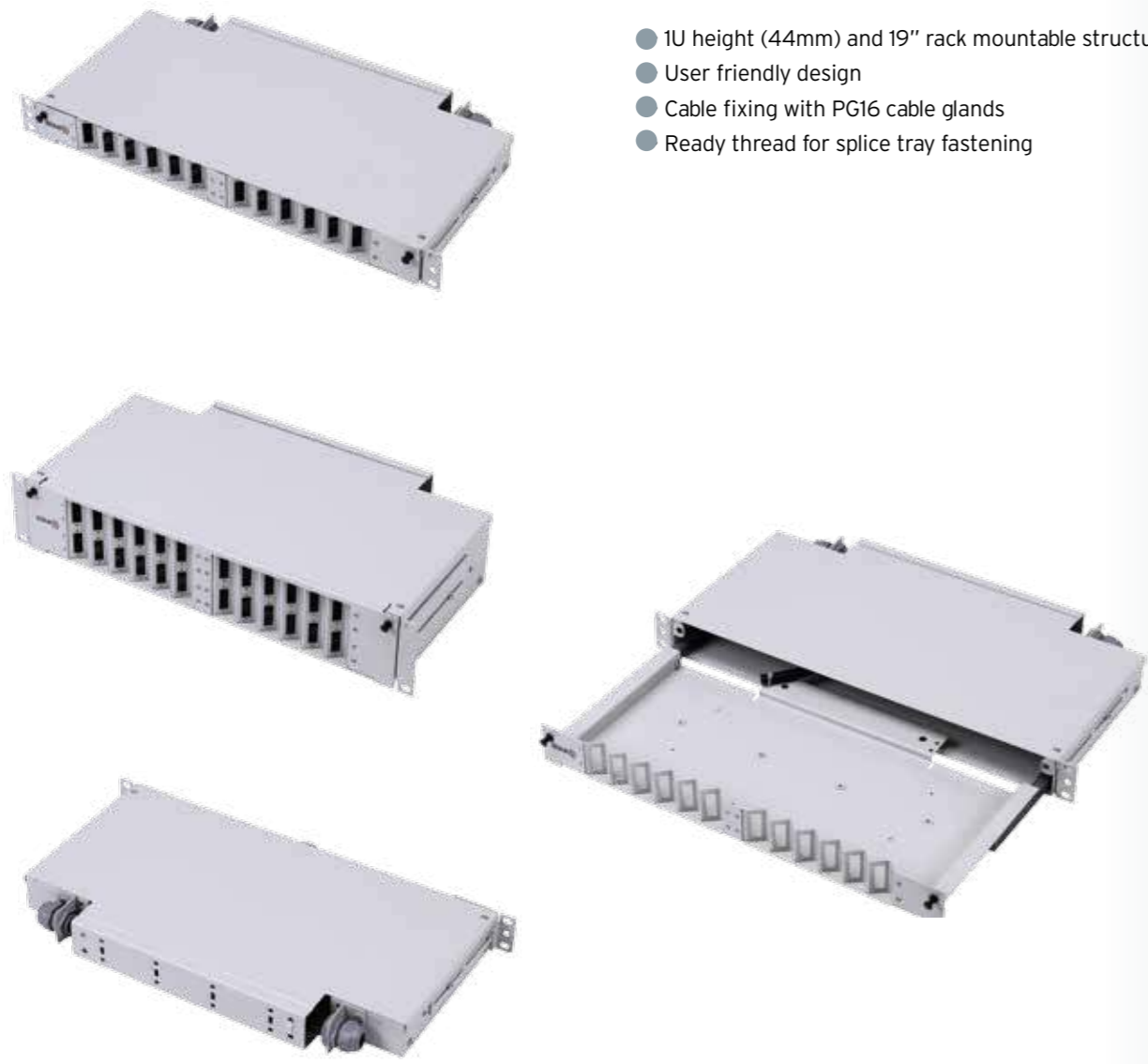

19" RACK MOUNT SPLICE BOX WITH ANGLED PANEL AND RAILS

Product Code	Product Description	Width (W) (mm)	Depth (D) (mm)	Height (H) (mm)	Weight (Kg)
1U19AF12PSCD CC	1U 19" 12 Port SC Duplex Fiber optic splice box with angled front panel & rails	483	245	44	5,0
2U19AF24PSCD CC	2U 19" 24 Port SC Duplex Fiber optic splice box with angled front panel & rails	483	245	88	7,5

**CC Means=Color Code, BL=Rail 9005 Black, LG=Rail 7035 Light Gray

3U ODF - Optical Distribution Frame

- 3U height (133mm) and 19" and 21" rack mountable structure
- User friendly design
- 3 different cable entrance that from top, sides and rear provide flexibility
- Easily openable-lockable transparent front cover
- Increased accessibility and facilitated cable management with easily openable rear cover
- Modular face plate provides variable capacity
- Ready thread for splice tray fastening



3U ODF - OPTICAL DISTRIBUTION BOX

Product Code	Product Description	Width (W) (mm)	Depth (D) (mm)	Height (H) (mm)	Weight (Kg)
3UODM72PSCD CC	3U 19" 72 Port SC Duplex Distribution Box	483 mm	260 mm	330 mm	7,50
3UODM72PSTS CC	3U 19" 72 Port ST Simplex Distribution Box	483 mm	260 mm	330 mm	7,50
3UODM72PSCS CC	3U 19" 72 Port SC Simplex Distribution Box	483 mm	260 mm	330 mm	7,50
3UODM72PLCD CC	3U 19" 72 Port LC Duplex Distribution Box	483 mm	260 mm	330 mm	7,50
3UODM72PFCS CC	3U 19" 72 Port FC Simplex Distribution Box	483 mm	260 mm	330 mm	7,5 0

**CC Means=Color Code, BL=Rail 9005 Black, LG=Rail 7035 Light Gray

4U Termination Box



- 4U height (178mm) and 19" and 21" rack mountable structure
- User friendly design
- Movable rack mounting brackets through depth
- 3 different cable entrance that from top, sides and rear provide flexibility
- Modular face plate provides variable capacity
- Easily openable-lockable transparent front cover
- Increased accessibility and facilitated cable management with easily openable rear cover
- Ready thread for splice tray fastening



Fiber Optic Distribution Box

- 4U height (178mm) and 19" and 21" rack mountable structure
- User friendly design
- Movable rack mounting brackets through depth
- 6 different cable entrance that from top, sides and rear provide flexibility
- Modular face plate provides variable capacity and different adapter foot-print
- Easily openable-lockable metal front cover
- Increased accessibility and facilitated cable management with easily openable rear cover

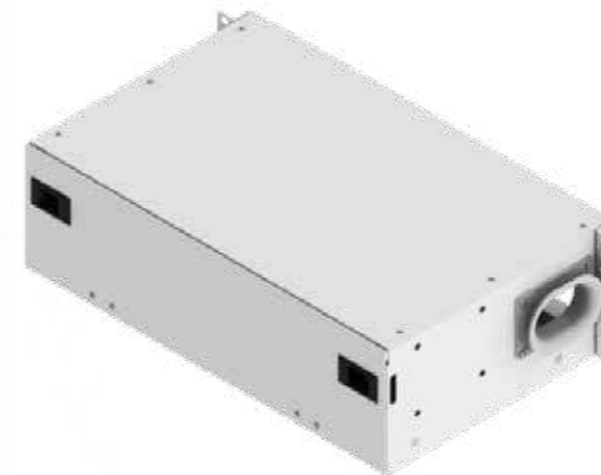

4U - TERMINATION BOX

Product Code	Product Description	Width (W) (mm)	Depth (D) (mm)	Height (H) (mm)	Weight (Kg)
4UODM84PSCD CC	4U 19" 84 Port SC Duplex Fiber optic termination box	483	305	178	8,00
4UODM112PSCS CC	4U 19" 112 Port SC Simplex Fiber optic termination box	483	305	178	8,00
4UODM98PSTS CC	4U 19" 98 Port ST Simplex Fiber optic termination box	483	305	178	8,00
4UODM84PLCD CC	4U 19" 84 Port LC Duplex Fiber optic termination box	483	305	178	8,00
4UODM98PFCS CC	4U 19" 98 Port FC Simplex Fiber optic termination box	483	305	178	8,00

FIBER OPTIC DISTRIBUTION BOX

Product Code	Product Description	Width (W) (mm)	Depth (D) (mm)	Height (H) (mm)	Weight (Kg)
GNK OFEM 2U 96K	2U 19" 96 port Termination Box with sliding tray	483	280	88	5,00
GNK OFEM 3U 144K	3U 19" 144 port Termination Box with sliding tray	483	280	133	5,50

**CC Means=Color Code, BL=Rail 9005 Black, LG=Rail 7035 Light Gray

**CC Means=Color Code, BL=Rail 9005 Black, LG=Rail 7035 Light Gray

WALL MOUNTING FIBER OPTIC SPLICE BOXES

- Solid and sturdy metal structure for wall mounting
- Lockable front cover
- User friendly design
- PG16 cable glands



M- TYPE WALL MOUNTING FIBER OPTIC SPLICE BOXES

Product Code	Product Description	Width (W) (mm)	Depth (D) (mm)	Height (H) (mm)	Weight (Kg)
WLOM48PSTS CC	48 Port St Simplex Wall mounting M Type fiber optic splice box	320	260	88	2,50
WLOM48PFCS CC	48 Port Fc Simplex Wall mounting M Type fiber optic splice box	320	260	88	2,50
WLOM24PSCS CC	24 Port Sc Simplex Wall mounting M Type fiber optic splice box	320	260	88	2,50
WLOM24PLCD CC	24 Port Lc Duplex Wall mounting M Type fiber optic splice box	320	260	88	2,50
WLOM24PSCD CC	24 Port Sc Duplex Wall mounting M Type fiber optic splice box	320	260	88	2,50
WLOM24PSTD CC	24 Port St Duplex Wall mounting M Type fiber optic splice box	320	260	88	2,50



S- TYPE WALL MOUNTING FIBER OPTIC SPLICE BOXES

Product Code	Product Description	Width (W) (mm)	Depth (D) (mm)	Height (H) (mm)	Weight (Kg)
WLOS04PSCD CC	4 Port SC Duplex Wall mounting (S) Type fiber optic splice box	170	210	50	1,00
WLOS08PSTS CC	8 Port ST Simplex Duplex Wall mounting (S) Type fiber optic splice box	170	210	50	1,00
WLOS06PSCS CC	6 Port SC Simplex Duplex Wall mounting (S) Type fiber optic splice box	170	210	50	1,00
WLOS04PLCD CC	4 Port LC Duplex Duplex Wall mounting (S) Type fiber optic splice box	170	210	50	1,00
WLOS08PFCS CC	8 Port FC Simplex Duplex Wall mounting (S) Type fiber optic splice box	170	210	50	1,00
WLOS04PSTD CC	4 Port ST Duplex Duplex Wall mounting (S) Type fiber optic splice box	170	210	50	1,00



SM- TYPE WALL MOUNTING FIBER OPTIC SPLICE BOXES

Product Code	Product Description	Width (W) (mm)	Depth (D) (mm)	Height (H) (mm)	Weight (Kg)
WLOSM08PSCD CC	08 Port Sc Duplex Wall mounting SM Type fiber optic splice box	320	260	50	1,80
WLOSM12PSCD CC	12 Port Sc Duplex Duplex Wall mounting SM Type fiber optic splice box	320	260	50	1,80

**CC Means=Color Code, BL=Rail 9005 Black, LG=Rail 7035 Light Gray

**CC Means=Color Code, BL=Rail 9005 Black, LG=Rail 7035 Light Gray

Wall Mounting Fiber Optic Splice Boxes

- Solid and sturdy metal structure for wall mounting
- Lockable front cover
- User friendly design with double section
- PG16 cable glands
- Ready thread for splice tray fastening

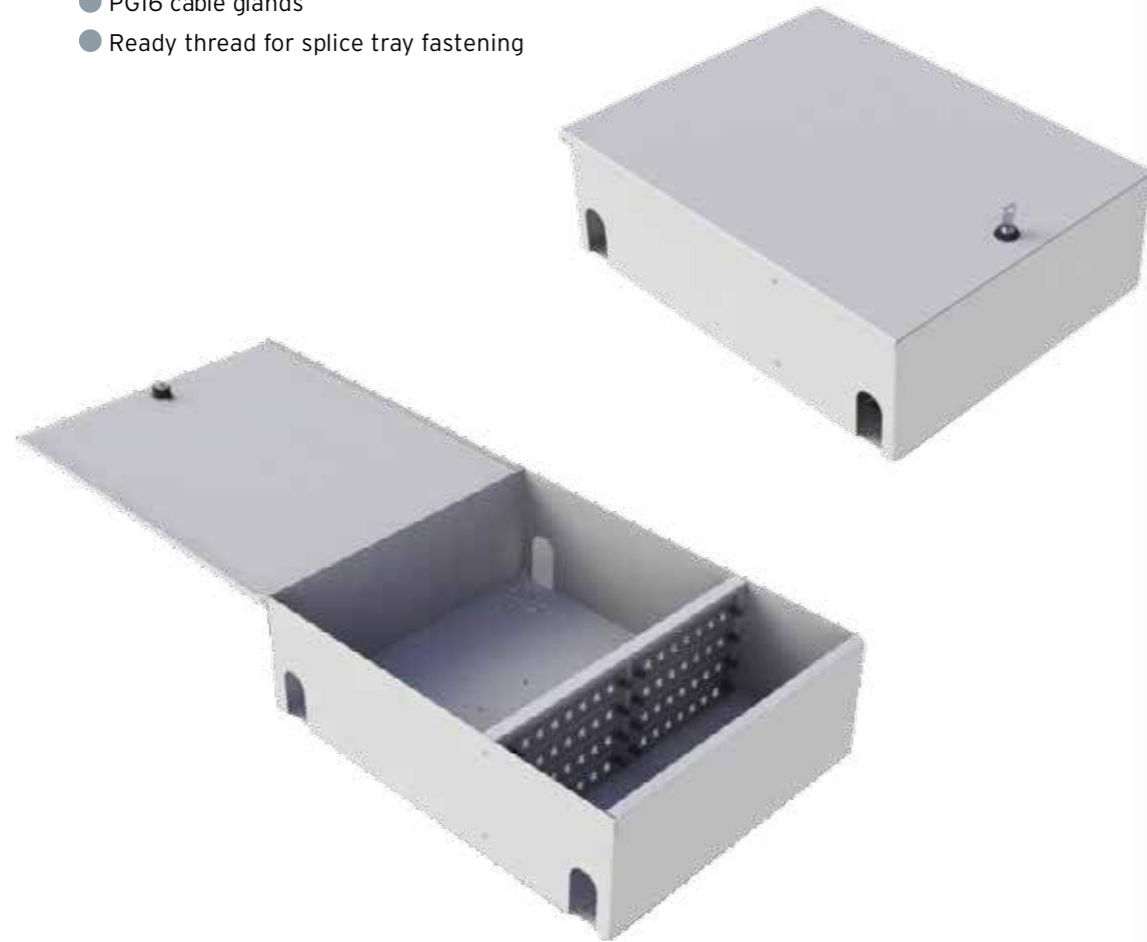

B- TYPE WALL MOUNTING FIBER OPTIC SPLICE BOXES

Product Code	Product Description	Width (W) (mm)	Depth (D) (mm)	Height (H) (mm)	Weight (Kg)
WLOB56PSTS CC	56 Port ST Simplex Wall mounting (B) Type fiber optic splice box	430	335	133	5,60
WLOB56PFCS CC	56 Port FC Simplex Wall mounting (B) Type fiber optic splice box	430	335	133	5,60
WLOB64PSCS CC	64 Port SC Simplex Wall mounting (B) Type fiber optic splice box	430	335	133	5,60
WLOB48PLCD CC	48 Port LC Duplex Wall mounting (B) Type fiber optic splice box	430	335	133	5,60
WLOB48PSCD CC	48 Port SC Duplex Wall mounting (B) Type fiber optic splice box	430	335	133	5,60
WLOB48PSTD CC	48 Port ST Duplex Wall mounting (B) Type fiber optic splice box	430	335	133	5,60

**CC Means=Color Code, BL=Rall 9005 Black, LG=Rall 7035 Light Gray

Wall Mounting Fiber Optic Splice Boxes

- Suitable for wall mounting applications,
- Lockable front door with 2 Hinges and barrel lock,
- Easy installation,
- Modular connector bracket,
- 6 Point cable entry
- Connection points for splice cassette



D- TYPE WALL MOUNTING FIBER OPTIC SPLICE BOXES

Product Code	Product Description	Width (W) (mm)	Depth (D) (mm)	Height (H) (mm)	Weight (Kg)
WLOD56PSTS CC	56 Port St Simplex Wall mounting (D) Type fiber optic splice box	420	335	133	5,30
WLOD56PFCS CC	56 Port FC Simplex Wall mounting (D) Type fiber optic splice box	420	335	133	5,30
WLOD64PSCS CC	64 Port SC Simplex Wall mounting (D) Type fiber optic splice box	420	335	133	5,30
WLOD48PLCD CC	48 Port LC Duplex Wall mounting (D) Type fiber optic splice box	420	335	133	5,30
WLOD48PSCD CC	48 Port SC Duplex Wall mounting (D) Type fiber optic splice box	420	335	133	5,30
WLOD48PSTD CC	48 Port ST Duplex Wall mounting (D) Type fiber optic splice box	420	335	133	5,30

**CC Means=Color Code, BL=Rall 9005 Black, LG=Rall 7035 Light Gray

OPTICAL DISTRIBUTION FRAME

- 900 x 300 x 2200mm (wxdxh)
- One pair of 42U 19" mounting rails
- Easily transform 19" system to 21" with L shape vertical rails without any additional parts
- Mounting rails movable throughout depth
- A lot of cable entrance gaps on bottom and top as brushed and pre-cutted
- Cable glands for fixing fiber cables and central element of cables
- Plastic cable holder and bend Radius protector parts on side cable Management modules
- Easily fixing brackets to ceiling or wall

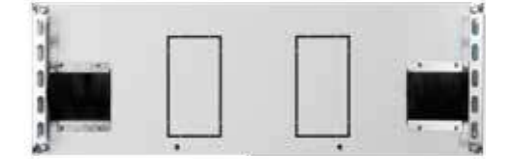

OPTICAL DISTRIBUTION FRAME

Product Code	Product Description	Genişlik (W) (mm)	Derinlik (D) (mm)	Vükseklik (H) (mm)	Ağırlık (Kg)
GNK OFDC 9322	GNK OFDC 9322 900 x 300 x 2200 Optical Distribution Frame 900 300 2200 110	900	300	2200	110

**CC Means=Color Code, BL=Rail 9005 Black, LG=Rail 7035 Light Gray

Certificates





Günko Endüstriyel Sistemler Sanayi ve Ticaret Ltd. Şti.

Head Office : İnönü Mah. Zümrüt Sok. Alize İş Merkezi
No: 3/3 Ataşehir / İSTANBUL / TÜRKİYE
Tel: +90 216 595 06 52
Fax: +90 (216) 595 07 84

Factory : Ramazanoğlu Mah. Gürsu Sokak No:13/B
Pendik / İSTANBUL / TÜRKİYE
Tel: +90 (216) 378 83 91 pbx
Fax: +90 (216) 378 80 24

www.gunko.com.tr